

Centrifugal Fans Model LSF

Louvered Roof Supply Fans

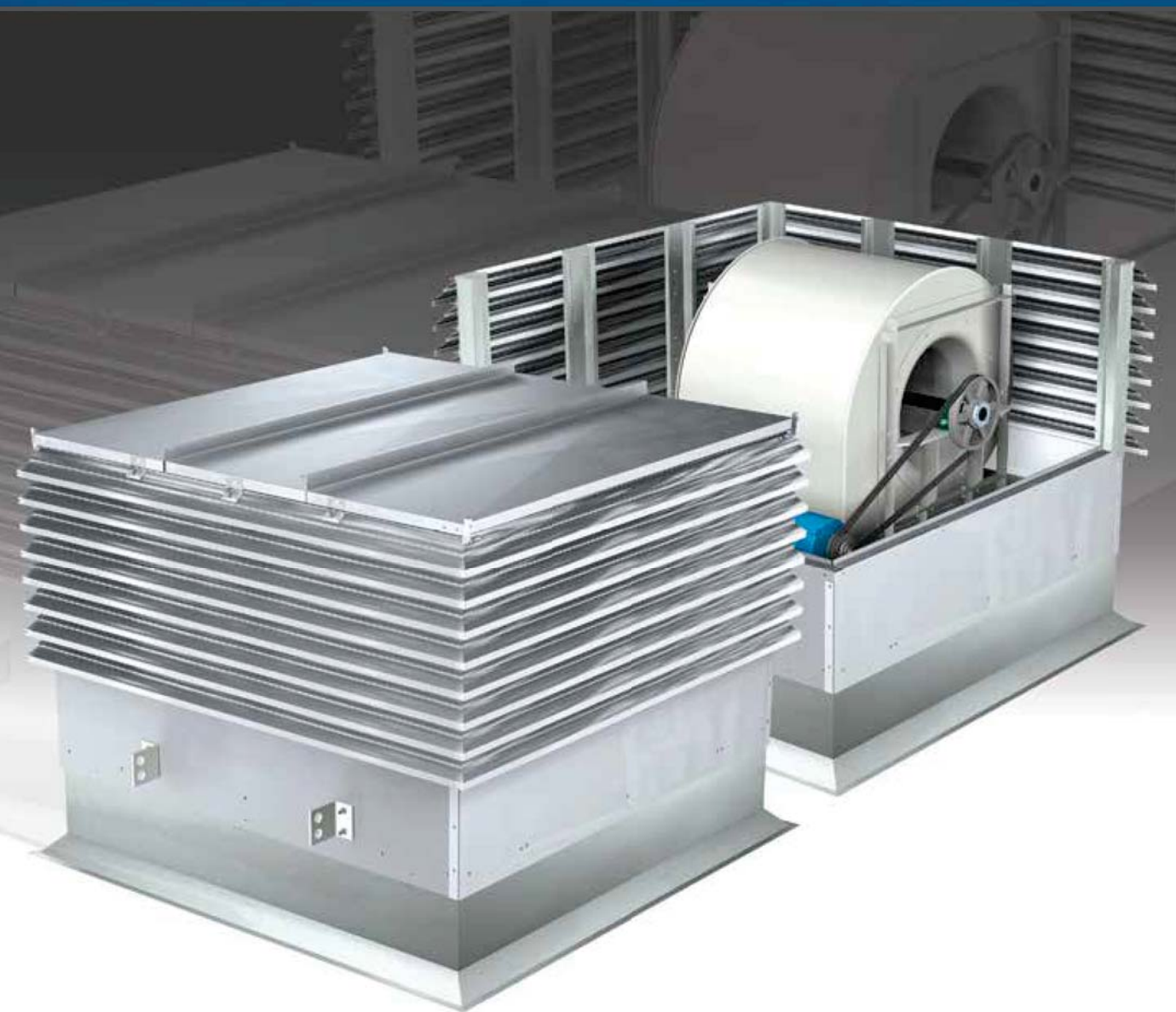

BUILDING VALUE IN AIR.

 **GREENHECK**
Building Value in Air.

May
2013



Greenheck model LSF louvered roof supply fans provide filtered make-up air in medium to high pressure/high volume applications. The louvered penthouse design provides an aesthetic look and is designed to allow for maximum air intake without the entry of rain and snow. For additional filtration of supply air, the LSF is available with 2-inch washable aluminum filters.

Model LSF roof supply fans are available in twelve wheel sizes, 12–36 in. (305–914 mm) with capacities from 800 to 37,000 cfm (1,360–62,860 m³/hr) and static pressures to 5.5 inches (1375 Pa). All fan sizes are air and sound tested to ensure complete and accurate performance ratings.

Wheels

LSF supply fans use double width centrifugal wheels. Heavy gauge wheels are constructed with flat blades (sizes 12–16) and airfoil blades (sizes 18–36) to provide efficient performance. All wheels are statically and dynamically balanced to grade G6.3 per ANSI S2.19.



Service Features

Filtered supply fans require regular inspection and cleaning (or replacement) of filters to ensure maximum efficiency and cataloged performance. Model LSF louvered penthouses are designed with hinged covers and quick release latches to permit easy access.

With covers open, LSF fans offer complete accessibility from above. Interior dimensions allow clearance for inspection, cleaning or maintenance of the motor, wheel, belt(s) and drives. Filter racks are designed to allow filters to slide out vertically for easy removal.

Compatible Products

Where model LSF fans are selected, a group of compatible products offer uniform appearance on the roof. All feature the same louvered penthouse styling.

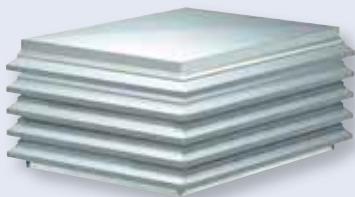

WIH/WRH

Gravity Intake and Relief



LDP/LBP

Centrifugal Roof Exhauster
Direct & Belt Drive



RSFP

Filtered Roof Supply Fan

The model LSF penthouse hood is constructed of heavy gauge extruded aluminum louvers. Fan sizes 12 thru 22 are fully factory assembled with mitered and welded corners. Penthouse hoods on sizes 24 thru 36 are shipped in sections. See complete details on page 5.

Hinged cover panels allow quick access to the motor and drive assembly. Covers are also insulated to prevent condensation.

Hood base panels include prepunched mounting holes for ease of installation on the roof curb.

The base also elevates the louvers above roof level for protection from splashing rain or drifting snow.



- 1 Motors** - Heavy duty motors are carefully matched to the fan load. See page 4 for motor options.
- 2 Motor Slide Base** - Motor bases are slide-adjustable for ease of maintaining proper belt tension. Bases for motors with frame sizes 182T and larger include a screw adjustment.
- 3 Shafts** - Shafts are precision turned, ground and polished steel sized so that the first critical speed is at least 25% over the maximum operating speed.
- 4 Drives** - Drives are sized for a minimum of 150% of driven horsepower and factory set to the desired rpm. Sheaves are machined cast iron and keyed securely to fan and motor shafts. Motor pulleys for up to 7½ hp motors are adjustable for final system balancing.
- 5 Bearings** - Highest quality bearings are mounted in cast iron pillow blocks with grease fittings. Bearings are designed specifically for air handling applications and are selected for a minimum L₁₀ life in excess of 80,000 hours. Precise self-alignment reduces vibration for longer bearing life.
- 6 Filters (Optional)** - Filters are permanent, washable, 2 in. (50.8 mm) aluminum mesh.
- 7 Filter Channels** - Formed aluminum filter channels allow filters to be easily removed or installed. Channels also provide rigid support for the louvered sides of the penthouse.
- 8 Lifting Lugs** - Lifting lugs are provided for ease of handling and installation with sizes 15 thru 36.
- 9 Fan Housings** - Double-width, double-inlet fan housings are constructed of heavy gauge steel.
- 10 Vibration Isolation Base** - Structural steel isolation bases with neoprene mounts limit noise transmission into the building and provide rigid support for fan wheels, motors and drives.



Duct Adapters

Duct adapters are mounted over the roof curb to locate the top of the duct, limit performance losses by directing airflow into the duct, and allow ductwork to be completed before the fan is set in place. Duct adapters are standard with all sizes.

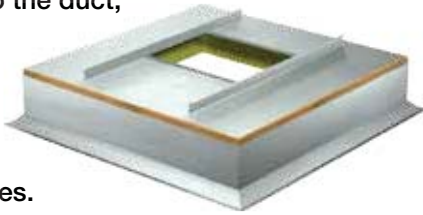

Roof Curbs

Model GPSHL prefabricated roof curbs are available for ease of fan installation and to reduce installation costs. Curbs are available in either 8 or 12 in. height (203 or 305 mm). Curbs for fan sizes 24 thru 36 are shipped in sections for ease of transportation and handling.

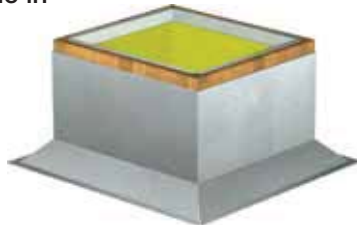

Dampers

Model VCD-1000 motorized intake dampers are designed for horizontal mounting inside ductwork. Actuators are available for 24, 115, 208, 230, 460 or 575 volt operation. Nominal damper sizes and recommended roof curb opening dimensions are shown in the Dimensional Data section of this catalog. Refer to the Typical Installation section for damper location.



Filters

Permanent, washable, 2 in. (50.8 mm) aluminum mesh.



Birdscreens

Rigid wire, 1/2 in. (13 mm) mesh screens are available in lieu of filters.

Motor Options

The chart shows available motor options. Single phase 115/230 volt motors are available up to 2 hp. Three phase motors are available up to 40 hp.



Single Speed					2 Speed 2 Winding	
Open		TE		Open		
115v 1 ph	230v 1 ph	*	115 or 230v 1 ph	*	115 or 230v 1 ph	**
		3 ph		3 ph		3 ph

* 1 speed, 3 phase motors are available in 200, 230/460 or 575 volt.

** 2 speed, 3 phase motors are available in either 200 or 230 volt up to 10 hp, 460 volt up to 40 hp; for 575 volt, consult factory.

Disconnect Switches

Disconnect switches allow positive electrical shutoff and safety when servicing the fan. NEMA-1 switches are interior mounted. NEMA-3R disconnects are exterior mounted on the fan base.



Motor Starters

The fundamental function of a motor starter is to protect the motor from damage that can occur from overheating. With a Greenheck motor starter you will be provided with the best motor protection available.



Available with up to 15 hp (460 volt) motors.

Specific model components may include SmartStart™ technology, physical interface, overload protection, disconnect, magnetic contactor, NEMA-1 and NEMA-3 steel enclosures and pre-engineered easy system integration. For complete information on specific Greenheck Motor Starter models, refer to our website, greenheck.com, and navigate to the Motor Starter webpage.

Handling and Installation (Sizes 24–36)

Sizes 24 through 36 are shipped in sections for ease of handling on the jobsite.

Once the fan components are on the roof, final assembly can be accomplished rapidly. Complete assembly procedures are found in the LSF Assembly Instructions.

NOTE: LSF sizes 24 and larger can be shipped completely assembled at additional cost. Consult factory for details.

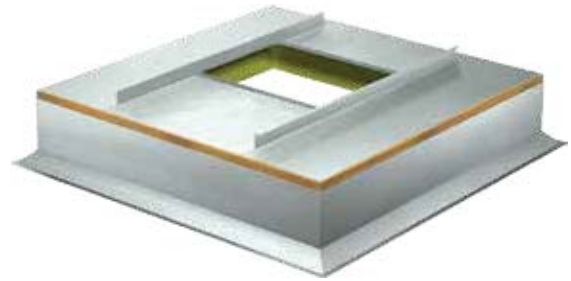

- 1 The assembled base pan is mounted on the roof curb. The base pan also serves as a duct adapter.



- 2 The motor, drives, blower and isolation base are shipped preassembled on the support frame. The complete assembly is then mounted over the base pan.



- 3 The exterior base panels and lower sections with covers are attached to the base support frame. Louver sections include filter racks.



- 4 Filters are inserted into the filter channels from above.



- 5 Center cover is installed, and side covers are closed.

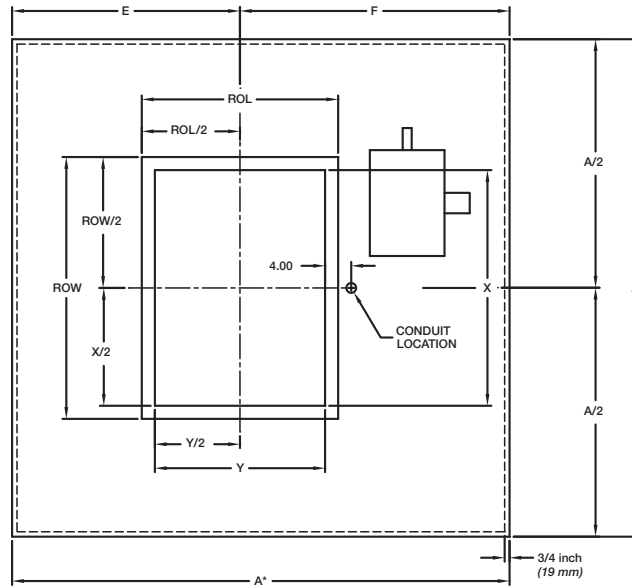
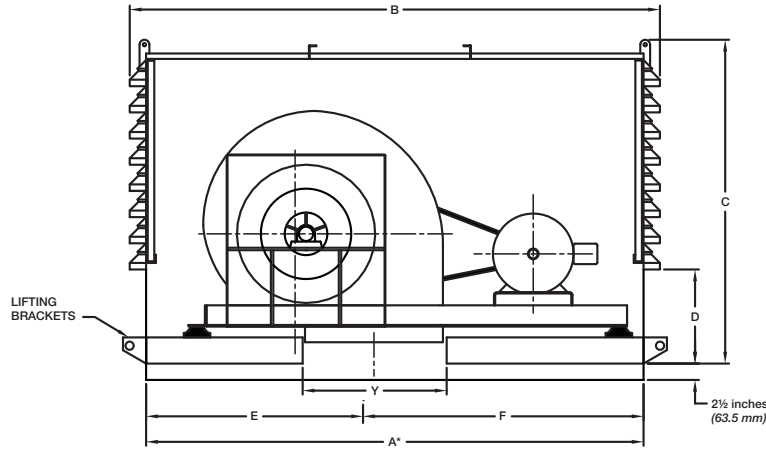

Unit Size	A sq.	B	C	D	E	F	Duct/Damper		Min. Roof Opening		Nominal Filter Sizes and Quantity (optional)	Louver Tiers	Weight (lbs.)
							X	Y	ROW	ROL			
12	46	51 ⁷ / ₈	35 ⁷ / ₁₆	12	19	27	18	14	22	18	16x20 (4), 20x20 (4)	5	445
13	52	57 ¹⁵ / ₁₆	35 ⁷ / ₁₆	12	20 ⁹ / ₁₆	31 ⁷ / ₁₆	20	16	24	20	20x20 (8)	5	500
15	58	64	35 ⁷ / ₁₆	12	22 ¹ / ₄	35 ³ / ₄	22	16	26	20	20x20 (4), 20x25 (4)	5	689
16	58	64	35 ⁷ / ₁₆	12	24 ⁷ / ₁₆	33 ³ / ₁₆	24	18	28	22	20x20 (4), 20x25 (4)	5	724
18	64	70	40 ¹⁵ / ₁₆	12	26 ³ / ₄	37 ¹ / ₄	26	20	30	24	25x25 (8)	6	901
20	70	76	45 ¹⁵ / ₁₆	17	29	41	30	22	34	26	20x25 (8), 16x25 (4)	6	1063
22	70	76	45 ¹⁵ / ₁₆	17	31 ⁷ / ₈	38 ³ / ₈	32	24	36	28	20x25 (8), 16x25 (4)	6	1148
24	76	82 ¹ / ₈	50 ¹ / ₈	14 ³ / ₈	34 ¹³ / ₁₆	41 ³ / ₁₆	36	26	40	30	16x20 (24)	8	1694
27	82	88 ¹ / ₈	54 ⁵ / ₈	18 ³ / ₈	38 ¹ / ₁₆	43 ¹⁵ / ₁₆	40	30	44	34	16x20 (16), 16x25 (8)	8	1931
30	88	94 ¹ / ₈ x 106 ¹ / ₈	56 ³ / ₈	19 ³ / ₈	42	46	44	32	48	36	16x25 (12), 20x25 (12)	9	2316
33	94	100 ¹ / ₈ x 112 ¹ / ₈	63 ³ / ₈	19 ³ / ₈	45 ⁷ / ₈	48 ¹ / ₈	48	36	52	40	20x20 (32)	10	2687
36	106	112 ¹ / ₈ x 124 ¹ / ₈	69 ⁵ / ₈	20 ³ / ₈	50 ³ / ₈	55 ⁵ / ₈	52	40	56	44	20x20(8), 25x25(8), 20x25(16)	11	3246

All dimensions shown are in inches.

*Dimension A given is the inside dimension of the fan curb cap.

The roof curb should be 1 1/2 inches (38 mm) less than the curb cap to allow for roofing and flashing.

For complete dimensional data, refer to the Greenheck CAPS (Computer Aided Product Selection) program.

The following is a typical installation for the Model LSF louvered supply fan showing recommended locations for accessories, options and items supplied by others. This arrangement offers ease of installation, safety and accessibility for service.

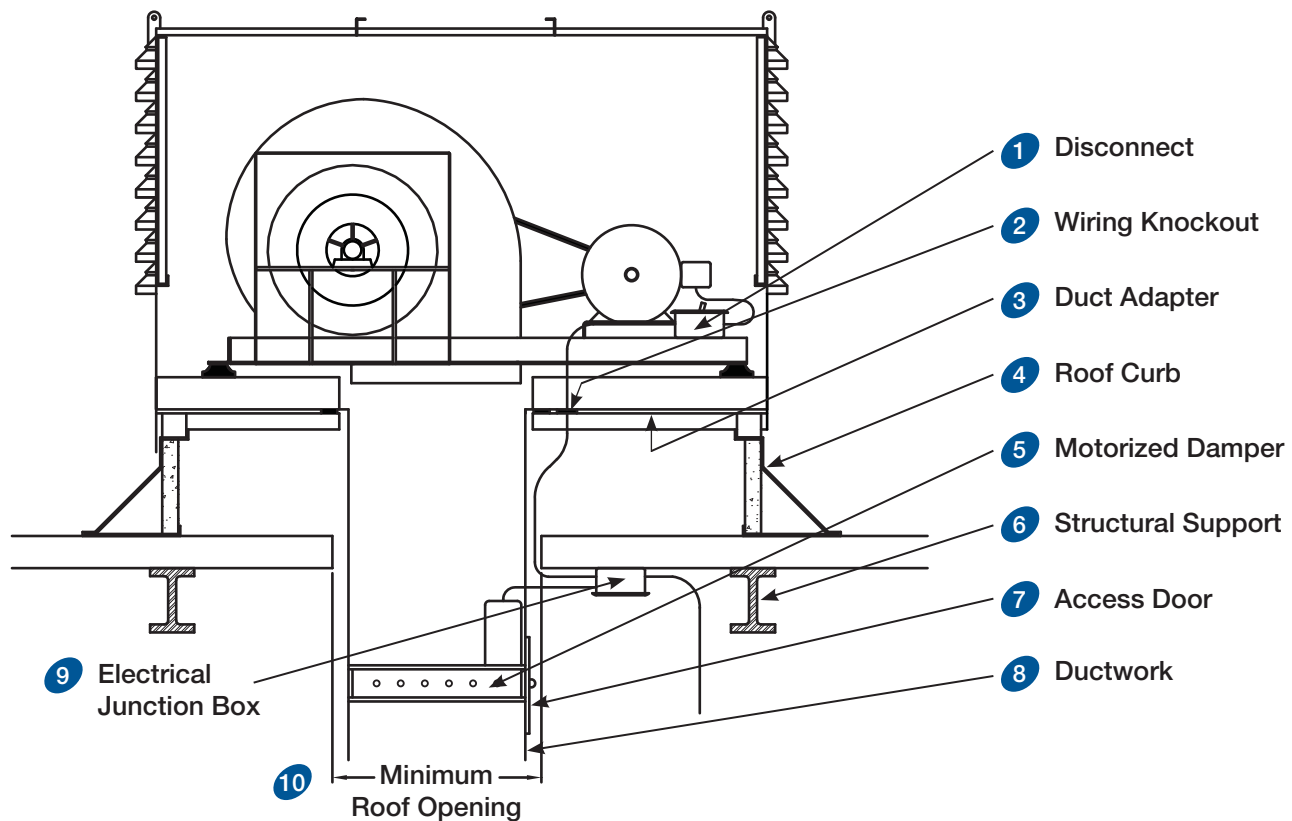

- 1 Electrical disconnects are recommended for safety while servicing the fan. Shown is the NEMA-1 enclosure, interior mounted.
- 2 Wiring knockouts are provided in the duct adapter and base pan.
- 3 The duct adapter fits over the roof curb and is located at the top of the duct to allow ductwork to be completed before the fan is set in place. Ductwork requires additional support.
- 4 Greenheck model GPSHL roof curbs are designed to bear and distribute the weight of the LSF. Curbs built by others must have equal capabilities.
- 5 Motorized dampers should be located below the roof line for ease of service.
- 6 It may be necessary to add additional supports beneath the load-carrying sides of the fan and roof curb as shown. See the Dimensional Data section for unit weights.
- 7 For ducted applications with motorized dampers, an access door located as shown in the duct allows access to the damper and actuator for service.
- 8 To reduce turbulence between the fan discharge and the damper, a minimum length of ductwork is recommended from the roof curb to the roof opening. This short length of duct should be used in non-ducted as well as ducted installations. (Minimum recommended length is three (3) wheel diameters).
- 9 The electrical junction box should be mounted in a location that permits ease of wiring the fan motor and damper actuator.
- 10 Minimum roof opening dimensions can be found in Dimension Data section. Roof openings may be larger if desired, depending on roof structure.

Maximum rpm	3205
Maximum Motor Frame Size	184T
Minimum Motor Size	1/3 [hp]
Maximum Motor Size	5 [hp]
Wheel Diameter	12.25 [in.] 311 [mm]
Outlet Area	1.55 [ft ²] 0.144 [m ²]
Outlet Velocity	cfm / 1.55 [ft/min] m ³ /s / 0.144 [m/s]
Peak Power	(rpm / 1981) ³ [ft/min] (rpm / 2185) ³ [m/s]
Tip Speed	rpm x 3.21 [ft/min] rpm x 0.0163 [m/s]

Imperial data – Metric data

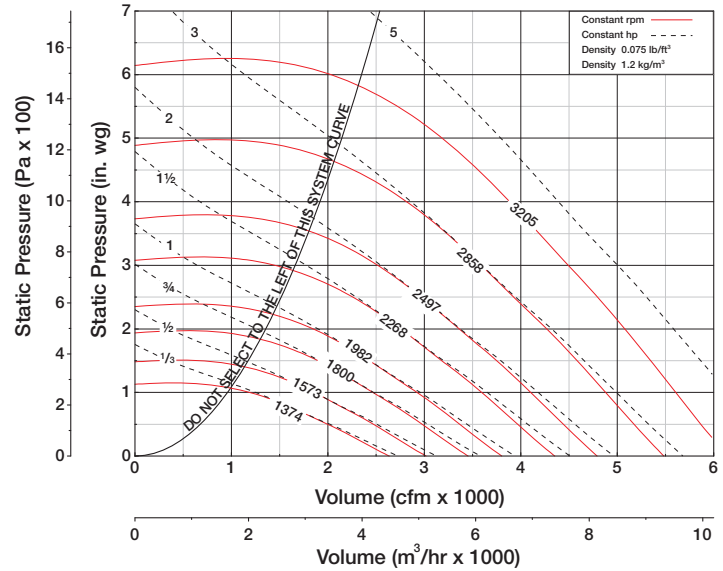

CFM	OV	STATIC PRESSURE (in. wg)																	
		0.00		0.25		0.50		0.75		1.00		1.25		1.50		1.75		2.00	
		RPM	BHP	RPM	BHP	RPM	BHP	RPM	BHP	RPM	BHP	RPM	BHP	RPM	BHP	RPM	BHP	RPM	BHP
1000	645	521	0.02	811	0.07	1013	0.13	1191	0.21	1347	0.29								
1300	838	678	0.04	927	0.10	1110	0.17	1265	0.26	1402	0.34	1539	0.44	1664	0.55	1778	0.66		
1600	1032	834	0.07	1049	0.14	1218	0.23	1362	0.32	1492	0.42	1608	0.53	1719	0.64	1833	0.76	1939	0.88
1900	1225	990	0.11	1180	0.20	1335	0.30	1468	0.41	1590	0.51	1704	0.63	1808	0.75	1905	0.87	1996	1.00
2200	1419	1147	0.17	1317	0.28	1456	0.39	1585	0.51	1698	0.63	1803	0.75	1905	0.88	2001	1.02	2090	1.16
2500	1612	1303	0.26	1457	0.38	1586	0.50	1704	0.62	1814	0.76	1914	0.90	2006	1.04	2099	1.18	2187	1.33
2800	1806	1460	0.36	1600	0.49	1720	0.63	1829	0.77	1933	0.91	2030	1.07	2120	1.22	2204	1.37	2287	1.53
3100	2000	1616	0.49	1746	0.64	1857	0.79	1959	0.94	2054	1.09	2149	1.26	2237	1.43	2319	1.59	2397	1.76
3400	2193	1772	0.64	1893	0.81	1996	0.97	2093	1.13	2184	1.30	2270	1.47	2355	1.65	2436	1.84	2512	2.02
3700	2387	1929	0.83	2042	1.01	2139	1.19	2230	1.36	2315	1.54	2397	1.72	2477	1.91	2555	2.11	2630	2.31
4000	2580	2085	1.05	2192	1.24	2283	1.43	2368	1.63	2450	1.82	2528	2.01	2603	2.21	2676	2.41	2749	2.63
4300	2774	2242	1.30	2342	1.51	2428	1.72	2509	1.92	2587	2.13	2662	2.34	2734	2.55	2803	2.76	2871	2.98
4600	2967	2398	1.59	2492	1.82	2575	2.04	2652	2.26	2726	2.48	2798	2.70	2866	2.92	2933	3.15	2998	3.38
4900	3161	2554	1.93	2643	2.17	2723	2.40	2796	2.64	2866	2.87	2935	3.11	3001	3.34	3065	3.58	3128	3.82
5200	3354	2711	2.30	2795	2.56	2871	2.81	2942	3.06	3009	3.31	3074	3.56	3138	3.80	3200	4.06		
5500	3548	2867	2.72	2947	2.99	3021	3.26	3088	3.52	3153	3.79								

CFM	OV	STATIC PRESSURE (in. wg)																	
		1.50		2.00		2.50		3.00		3.50		4.00		4.50		5.00		5.50	
		RPM	BHP	RPM	BHP	RPM	BHP	RPM	BHP	RPM	BHP	RPM	BHP	RPM	BHP	RPM	BHP	RPM	BHP
2000	1290	1840	0.79	2027	1.05	2207	1.33	2382	1.64	2544	1.96	2695	2.29						
2150	1387	1889	0.86	2074	1.13	2240	1.42	2410	1.73	2571	2.06	2722	2.40	2863	2.76	2997	3.13		
2300	1483	1938	0.93	2122	1.21	2287	1.51	2438	1.82	2599	2.16	2749	2.52	2890	2.89	3024	3.26	3152	3.65
2450	1580	1989	1.01	2171	1.30	2334	1.61	2483	1.93	2627	2.27	2777	2.64	2918	3.01	3051	3.40	3179	3.80
2600	1677	2044	1.09	2220	1.40	2382	1.72	2530	2.05	2668	2.39	2804	2.76	2945	3.15	3079	3.55		
2750	1774	2101	1.19	2270	1.50	2431	1.83	2578	2.17	2715	2.53	2843	2.89	2973	3.28	3106	3.69		
2900	1870	2159	1.28	2321	1.60	2480	1.95	2626	2.30	2762	2.67	2890	3.05	3010	3.44	3134	3.85		
3050	1967	2217	1.39	2378	1.72	2530	2.07	2675	2.44	2810	2.82	2937	3.21	3057	3.61	3171	4.01		
3200	2064	2276	1.50	2435	1.85	2580	2.20	2724	2.58	2859	2.97	2985	3.37	3104	3.78				
3350	2161	2335	1.61	2493	1.98	2636	2.35	2774	2.73	2908	3.13	3033	3.55	3152	3.97				
3500	2258	2396	1.74	2552	2.12	2693	2.50	2825	2.89	2957	3.30	3082	3.73	3200	4.16				
3650	2354	2456	1.87	2610	2.26	2750	2.66	2880	3.06	3007	3.48	3131	3.92						
3800	2451	2518	2.01	2670	2.41	2809	2.83	2937	3.24	3058	3.67	3181	4.11						
3950	2548	2582	2.16	2729	2.57	2867	3.00	2994	3.43	3114	3.87								
4100	2645	2647	2.32	2790	2.74	2926	3.19	3052	3.63	3171	4.08								
4250	2741	2712	2.49	2851	2.92	2985	3.37	3111	3.84										

Performance shown is for model LSF with outlet duct. Power ratings (Bhp) do not include transmission losses.

Maximum rpm	2908
Maximum Motor Frame Size	184T
Minimum Motor Size	1/2 [hp]
Maximum Motor Size	5 [hp]
Wheel Diameter	13.50 [in.] 343 [mm]
Outlet Area	1.89 [ft ²] 0.176 [m ²]
Outlet Velocity	cfm / 1.89 [ft/min] m ³ /s / 0.176 [m/s]
Peak Power	(rpm / 1647) ³ [ft/min] (rpm / 1816) ³ [m/s]
Tip Speed	rpm x 3.53 [ft/min] rpm x 0.0180 [m/s]

Imperial data – Metric data

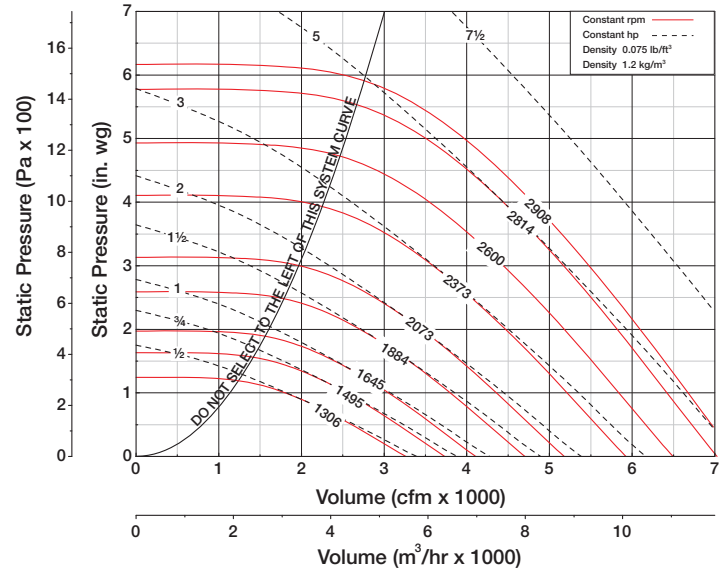

CFM	OV	STATIC PRESSURE (in. wg)																	
		0.00		0.25		0.50		0.75		1.00		1.25		1.50		1.75		2.00	
		RPM	BHP	RPM	BHP	RPM	BHP	RPM	BHP	RPM	BHP	RPM	BHP	RPM	BHP	RPM	BHP	RPM	BHP
1000	529	400	0.01	676	0.07	878	0.14	1039	0.23										
1400	740	561	0.04	785	0.11	953	0.19	1104	0.29	1239	0.40	1358	0.51	1466	0.63				
1800	952	721	0.07	910	0.16	1058	0.26	1189	0.38	1306	0.49	1424	0.62	1531	0.76	1630	0.90	1723	1.05
2200	1164	881	0.14	1045	0.24	1176	0.36	1294	0.48	1404	0.62	1505	0.76	1599	0.91	1697	1.06	1788	1.23
2600	1375	1041	0.22	1184	0.35	1305	0.48	1412	0.63	1512	0.77	1606	0.93	1696	1.09	1780	1.26	1859	1.43
3000	1587	1201	0.35	1329	0.49	1439	0.64	1538	0.80	1630	0.96	1717	1.13	1799	1.30	1880	1.49	1958	1.67
3400	1798	1361	0.50	1477	0.67	1577	0.84	1670	1.01	1755	1.19	1836	1.37	1915	1.56	1988	1.76	2060	1.96
3800	2010	1522	0.70	1627	0.89	1719	1.07	1806	1.26	1887	1.46	1962	1.66	2034	1.87	2106	2.08	2174	2.29
4200	2222	1682	0.95	1778	1.16	1864	1.36	1944	1.56	2021	1.78	2093	2.00	2161	2.22	2226	2.44	2292	2.67
4600	2433	1842	1.25	1931	1.48	2011	1.69	2086	1.92	2158	2.15	2227	2.38	2293	2.62	2355	2.87	2415	3.11
5000	2645	2002	1.60	2085	1.85	2160	2.09	2230	2.33	2298	2.58	2364	2.83	2427	3.09	2487	3.35	2544	3.61
5400	2857	2162	2.01	2240	2.29	2310	2.55	2377	2.81	2440	3.07	2503	3.34	2563	3.61	2621	3.89	2677	4.17
5800	3068	2322	2.50	2396	2.80	2462	3.07	2525	3.35	2585	3.63	2643	3.91	2701	4.20	2757	4.50	2811	4.79
6200	3280	2483	3.05	2552	3.37	2614	3.67	2674	3.96	2731	4.26	2787	4.56	2841	4.86	2895	5.18		
6600	3492	2643	3.68	2708	4.03	2768	4.34	2824	4.65	2879	4.97								
7000	3703	2803	4.39	2865	4.76														

CFM	OV	STATIC PRESSURE (in. wg)																	
		1.50		2.00		2.50		3.00		3.50		4.00		4.500		5.00		5.50	
		RPM	BHP	RPM	BHP	RPM	BHP	RPM	BHP	RPM	BHP	RPM	BHP	RPM	BHP	RPM	BHP	RPM	BHP
2500	1322	1671	1.04	1839	1.37	2006	1.74	2158	2.12	2298	2.52	2429	2.93	2552	3.35				
2700	1428	1721	1.14	1883	1.49	2040	1.86	2191	2.26	2331	2.67	2461	3.10	2584	3.54	2700	3.99	2811	4.46
2900	1534	1772	1.25	1933	1.61	2076	1.99	2225	2.40	2364	2.83	2494	3.27	2617	3.73	2733	4.20	2843	4.68
3100	1640	1827	1.36	1983	1.74	2125	2.14	2259	2.55	2398	3.00	2527	3.46	2649	3.93	2765	4.42	2876	4.92
3300	1746	1885	1.49	2034	1.88	2175	2.30	2305	2.72	2432	3.17	2561	3.65	2683	4.14	2798	4.64		
3500	1851	1944	1.63	2087	2.03	2226	2.46	2354	2.91	2474	3.37	2595	3.85	2716	4.35	2831	4.87		
3700	1957	2004	1.79	2145	2.20	2277	2.64	2404	3.10	2523	3.58	2634	4.06	2750	4.58	2865	5.11		
3900	2063	2064	1.95	2203	2.38	2330	2.83	2455	3.31	2573	3.80	2684	4.30	2788	4.82	2899	5.36		
4100	2169	2129	2.12	2262	2.57	2387	3.04	2507	3.53	2623	4.03	2733	4.55	2837	5.08				
4300	2275	2194	2.31	2322	2.78	2445	3.26	2560	3.75	2674	4.28	2783	4.81	2887	5.36				
4500	2380	2259	2.52	2383	3.00	2504	3.49	2618	4.01	2726	4.54	2834	5.09						
4700	2486	2326	2.73	2447	3.23	2564	3.74	2676	4.27	2781	4.81	2886	5.38						
4900	2592	2393	2.96	2512	3.48	2624	4.01	2735	4.55	2839	5.11								
5100	2698	2460	3.21	2577	3.74	2686	4.29	2794	4.85	2897	5.42								
5300	2804	2529	3.47	2643	4.02	2750	4.58	2854	5.16										
5500	2910	2597	3.75	2710	4.32	2815	4.90												

Performance shown is for model LSF with outlet duct. Power ratings (Bhp) do not include transmission losses.

Maximum rpm	2617
Maximum Motor Frame Size	213T
Minimum Motor Size	1/2 [hp]
Maximum Motor Size	7½ [hp]
Wheel Diameter	15.00 [in.] 381 [mm]
Outlet Area	2.33 [ft²] 0.216 [m²]
Outlet Velocity	cfm / 2.33 [ft/min] m³/s / 0.216 [m/s]
Peak Power	(rpm / 1385)³ [ft/min] (rpm / 1527)³ [m/s]
Tip Speed	rpm x 3.93 [ft/min] rpm x 0.0199 [m/s]

Imperial data – Metric data

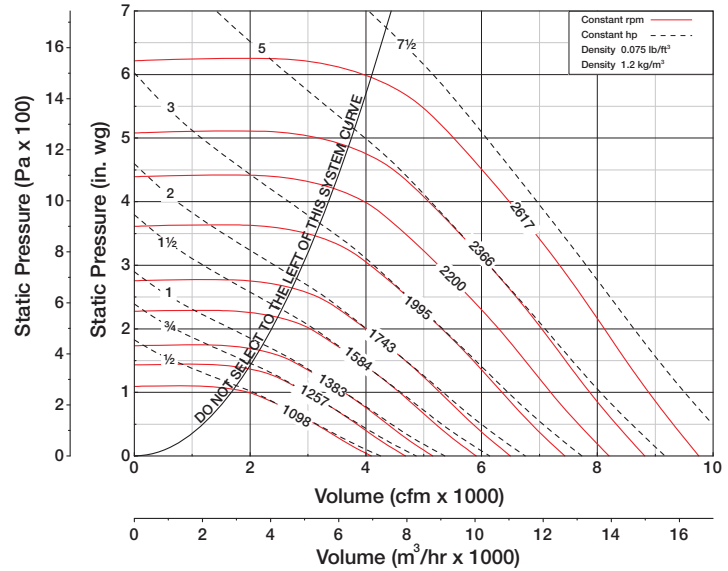

CFM	OV	STATIC PRESSURE (in. wg)																	
		0.00		0.25		0.50		0.75		1.00		1.25		1.50		1.75		2.00	
		RPM	BHP	RPM	BHP	RPM	BHP	RPM	BHP	RPM	BHP	RPM	BHP	RPM	BHP	RPM	BHP	RPM	BHP
1500	643	402	0.02	632	0.10	790	0.18	933	0.29										
2000	858	537	0.05	731	0.15	871	0.25	992	0.36	1103	0.49	1210	0.63						
2500	1072	671	0.10	839	0.22	966	0.34	1077	0.47	1176	0.61	1269	0.76	1355	0.91	1445	1.08	1528	1.26
3000	1287	805	0.18	956	0.32	1070	0.46	1171	0.61	1264	0.76	1349	0.92	1431	1.09	1508	1.27	1580	1.46
3500	1502	939	0.28	1076	0.45	1179	0.61	1273	0.77	1359	0.95	1442	1.13	1516	1.31	1587	1.50	1658	1.70
4000	1716	1073	0.42	1199	0.61	1294	0.80	1380	0.98	1461	1.17	1537	1.37	1610	1.57	1678	1.78	1744	1.99
4500	1931	1207	0.59	1322	0.81	1413	1.02	1492	1.23	1568	1.44	1640	1.65	1706	1.87	1773	2.10	1837	2.33
5000	2145	1341	0.81	1446	1.06	1534	1.30	1609	1.52	1678	1.76	1746	1.99	1811	2.23	1872	2.47	1932	2.72
5500	2360	1476	1.08	1572	1.35	1657	1.62	1727	1.87	1794	2.12	1856	2.38	1918	2.64	1977	2.90	2034	3.16
6000	2575	1610	1.40	1699	1.70	1779	2.00	1848	2.28	1911	2.55	1971	2.82	2028	3.10	2085	3.38	2139	3.67
6500	2789	1744	1.78	1826	2.10	1903	2.43	1971	2.74	2030	3.03	2087	3.33	2142	3.63	2194	3.93	2247	4.23
7000	3004	1878	2.23	1955	2.57	2027	2.92	2094	3.27	2152	3.59	2206	3.90	2258	4.22	2309	4.54	2357	4.87
7500	3218	2012	2.74	2084	3.11	2152	3.48	2216	3.86	2274	4.21	2326	4.55	2377	4.89	2425	5.23	2472	5.58
8000	3433	2146	3.32	2214	3.72	2279	4.11	2340	4.51	2398	4.92	2448	5.27	2496	5.63	2543	6.00	2588	6.36
8500	3648	2280	3.98	2345	4.40	2406	4.82	2464	5.25	2520	5.68	2571	6.08						
9000	3862	2414	4.73	2475	5.17	2534	5.62	2589	6.07										

CFM	OV	STATIC PRESSURE (in. wg)																	
		1.50		2.00		2.50		3.00		3.50		4.00		4.50		5.00		5.50	
		RPM	BHP	RPM	BHP	RPM	BHP	RPM	BHP	RPM	BHP	RPM	BHP	RPM	BHP	RPM	BHP	RPM	BHP
3250	1394	1471	1.20	1619	1.58	1751	1.97	1889	2.42	2016	2.88								
3500	1502	1516	1.31	1658	1.70	1789	2.12	1913	2.56	2040	3.04	2158	3.54						
3750	1609	1562	1.44	1698	1.84	1828	2.27	1947	2.73	2064	3.20	2181	3.72	2292	4.25	2398	4.80		
4000	1716	1610	1.57	1744	1.99	1868	2.44	1986	2.91	2096	3.39	2205	3.91	2316	4.46	2421	5.02	2521	5.60
4250	1824	1658	1.72	1790	2.16	1909	2.62	2025	3.10	2134	3.60	2236	4.12	2340	4.67	2444	5.25	2544	5.85
4500	1931	1706	1.87	1837	2.33	1955	2.81	2065	3.30	2173	3.82	2275	4.36	2371	4.91	2468	5.49	2568	6.10
4750	2038	1758	2.04	1884	2.52	2001	3.01	2109	3.52	2213	4.06	2314	4.61	2409	5.18	2500	5.76	2592	6.37
5000	2145	1811	2.23	1932	2.72	2048	3.23	2154	3.76	2254	4.30	2353	4.87	2448	5.46	2539	6.06		
5250	2253	1864	2.42	1981	2.93	2095	3.46	2200	4.01	2299	4.57	2393	5.14	2488	5.75	2578	6.37		
5500	2360	1918	2.64	2034	3.16	2143	3.71	2248	4.27	2345	4.85	2438	5.44	2527	6.05				
5750	2467	1973	2.86	2086	3.41	2191	3.97	2295	4.55	2392	5.15	2483	5.76	2571	6.38				
6000	2575	2028	3.10	2139	3.67	2242	4.25	2343	4.84	2439	5.46	2529	6.09	2616	6.73				
6250	2682	2084	3.36	2193	3.94	2295	4.54	2391	5.15	2486	5.79	2577	6.44						
6500	2789	2142	3.63	2247	4.23	2347	4.85	2441	5.48	2534	6.13								
6750	2896	2200	3.92	2302	4.54	2401	5.18	2493	5.83	2582	6.49								
7000	3004	2258	4.22	2357	4.87	2455	5.53	2546	6.19										

Performance shown is for model LSF with outlet duct. Power ratings (Bhp) do not include transmission losses.

Maximum rpm	2379
Maximum Motor Frame Size	213T
Minimum Motor Size	1/2 [hp]
Maximum Motor Size	7½ [hp]
Wheel Diameter	16.50 [in.] 419 [mm]
Outlet Area	2.82 [ft²] 0.262 [m²]
Outlet Velocity	cfm / 2.82 [ft/min] m³/s / 0.262 [m/s]
Peak Power	(rpm / 1168)³ [ft/min] (rpm / 1288)³ [m/s]
Tip Speed	rpm x 4.32 [ft/min] rpm x 0.0219 [m/s]

Imperial data – Metric data

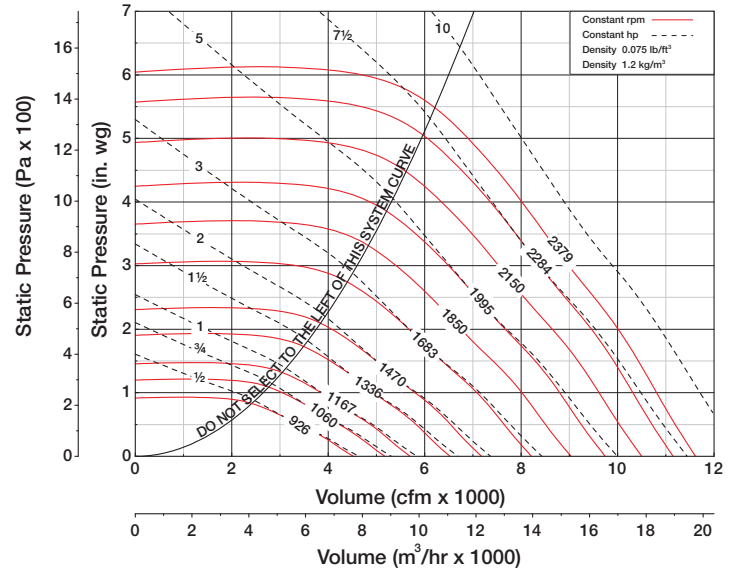

CFM	OV	STATIC PRESSURE (in. wg)																	
		0.00		0.25		0.50		0.75		1.00		1.25		1.50		1.75		2.00	
		RPM	BHP	RPM	BHP	RPM	BHP	RPM	BHP	RPM	BHP	RPM	BHP	RPM	BHP	RPM	BHP	RPM	BHP
2000	709	410	0.04	594	0.13	731	0.23												
2600	921	532	0.09	688	0.20	809	0.33	912	0.46										
3200	1134	655	0.16	784	0.30	897	0.45	992	0.61	1078	0.77	1161	0.93						
3800	1347	778	0.27	889	0.43	992	0.61	1080	0.79	1161	0.97	1236	1.16	1305	1.35	1375	1.55	1441	1.76
4400	1560	901	0.43	998	0.61	1087	0.80	1175	1.02	1249	1.22	1319	1.44	1386	1.65	1448	1.87	1508	2.09
5000	1773	1024	0.63	1112	0.83	1191	1.04	1270	1.27	1343	1.52	1409	1.76	1470	2.00	1531	2.24	1590	2.48
5600	1985	1147	0.88	1227	1.11	1297	1.34	1368	1.58	1438	1.86	1504	2.13	1563	2.39	1619	2.66	1673	2.93
6200	2198	1270	1.19	1344	1.45	1407	1.70	1472	1.96	1534	2.24	1599	2.55	1658	2.85	1712	3.15	1763	3.44
6800	2411	1393	1.57	1462	1.86	1521	2.13	1578	2.41	1637	2.71	1694	3.02	1753	3.36	1807	3.70	1857	4.02
7400	2624	1515	2.03	1580	2.34	1635	2.64	1687	2.93	1742	3.25	1795	3.57	1848	3.92	1902	4.29	1953	4.67
8000	2836	1638	2.56	1698	2.90	1751	3.23	1800	3.54	1848	3.87	1899	4.22	1948	4.57	1997	4.95	2047	5.35
8600	3049	1761	3.19	1817	3.55	1868	3.90	1914	4.24	1958	4.58	2005	4.95	2052	5.33	2097	5.71	2143	6.11
9200	3262	1884	3.90	1937	4.29	1986	4.67	2029	5.04	2071	5.40	2112	5.77	2157	6.17	2201	6.57	2243	6.98
9800	3475	2007	4.71	2056	5.13	2103	5.54	2145	5.93	2185	6.32	2224	6.71	2264	7.11	2306	7.54	2347	7.97
10400	3687	2130	5.63	2176	6.07	2221	6.51	2262	6.93	2300	7.34	2337	7.75	2373	8.17				
11000	3900	2253	6.67	2297	7.13	2339	7.59												

CFM	OV	STATIC PRESSURE (in. wg)																	
		1.50		2.00		2.50		3.00		3.50		4.00		4.50		5.00		5.50	
		RPM	BHP	RPM	BHP	RPM	BHP	RPM	BHP	RPM	BHP	RPM	BHP	RPM	BHP	RPM	BHP	RPM	BHP
5000	1773	1470	2.00	1590	2.48	1696	2.98	1803	3.51	1904	4.04								
5250	1861	1509	2.16	1624	2.66	1730	3.18	1831	3.72	1931	4.27								
5500	1950	1547	2.32	1659	2.85	1765	3.39	1861	3.94	1959	4.52	2052	5.10						
5750	2039	1586	2.50	1694	3.06	1799	3.61	1895	4.18	1987	4.77	2080	5.37	2167	5.99				
6000	2127	1626	2.69	1732	3.27	1834	3.85	1930	4.43	2019	5.03	2108	5.65	2195	6.29	2278	6.93		
6250	2216	1666	2.90	1771	3.49	1869	4.09	1964	4.70	2052	5.31	2136	5.94	2223	6.60	2306	7.26		
6500	2304	1706	3.11	1810	3.72	1905	4.34	1999	4.97	2087	5.61	2170	6.26	2251	6.92	2333	7.61		
6750	2393	1745	3.32	1849	3.96	1943	4.61	2034	5.26	2121	5.92	2204	6.58	2282	7.26	2362	7.96		
7000	2482	1784	3.54	1889	4.22	1982	4.89	2069	5.56	2156	6.24	2238	6.92	2315	7.62				
7250	2570	1824	3.77	1929	4.50	2021	5.18	2107	5.87	2191	6.57	2273	7.28	2350	7.99				
7500	2659	1864	4.02	1969	4.78	2060	5.48	2145	6.20	2226	6.92	2307	7.65						
7750	2748	1905	4.28	2008	5.06	2099	5.80	2184	6.54	2263	7.28	2342	8.03						
8000	2836	1948	4.57	2047	5.35	2139	6.14	2223	6.89	2301	7.65	2377	8.43						
8250	2925	1991	4.88	2087	5.66	2179	6.49	2262	7.26	2340	8.04								
8500	3014	2035	5.19	2127	5.98	2219	6.84	2301	7.64	2379	8.45								
8750	3102	2078	5.53	2167	6.31	2258	7.19	2341	8.04										

Performance shown is for model LSF with outlet duct. Power ratings (Bhp) do not include transmission losses.

Maximum rpm	2389
Maximum Motor Frame Size	215T
Minimum Motor Size	3/4 [hp]
Maximum Motor Size	10 [hp]
Wheel Diameter	18.25 [in.] 464 [mm]
Outlet Area	3.45 [ft ²] 0.321 [m ²]
Outlet Velocity	cfm / 3.45 [ft/min] m ³ /s / 0.321 [m/s]
Peak Power	(rpm / 1140) ³ [ft/min] (rpm / 1257) ³ [m/s]
Tip Speed	rpm x 4.78 [ft/min] rpm x 0.0243 [m/s]

Imperial data – Metric data

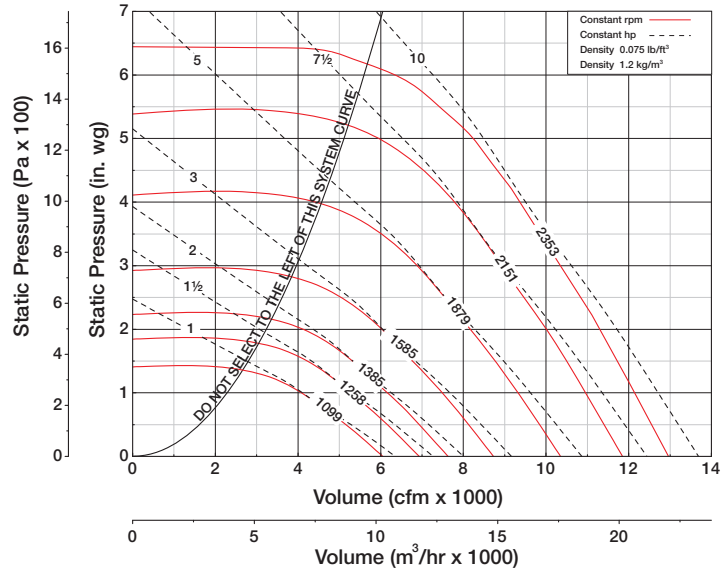

CFM	OV	STATIC PRESSURE (in. wg)																	
		0.00		0.25		0.50		0.75		1.00		1.25		1.50		1.75		2.00	
		RPM	BHP	RPM	BHP	RPM	BHP	RPM	BHP	RPM	BHP	RPM	BHP	RPM	BHP	RPM	BHP	RPM	BHP
3000	869	545	0.11	681	0.23	792	0.37	891	0.52	988	0.69	1079	0.87	1169	1.07				
3600	1043	654	0.18	770	0.33	872	0.49	960	0.66	1042	0.83	1127	1.04	1204	1.24	1278	1.46	1356	1.69
4200	1217	762	0.29	865	0.46	957	0.64	1039	0.84	1114	1.03	1185	1.23	1257	1.45	1328	1.69	1394	1.93
4800	1391	871	0.43	963	0.62	1046	0.83	1123	1.05	1193	1.27	1258	1.49	1322	1.72	1382	1.95	1447	2.21
5400	1565	980	0.61	1063	0.83	1137	1.05	1210	1.29	1277	1.54	1338	1.79	1396	2.04	1454	2.3	1510	2.55
6000	1739	1089	0.84	1164	1.08	1233	1.32	1299	1.58	1363	1.85	1422	2.13	1477	2.41	1530	2.69	1583	2.97
6600	1913	1198	1.12	1267	1.38	1331	1.65	1390	1.92	1451	2.21	1508	2.51	1562	2.82	1612	3.12	1661	3.43
7200	2086	1307	1.45	1371	1.74	1430	2.03	1486	2.32	1540	2.63	1595	2.95	1647	3.28	1697	3.62	1744	3.94
7800	2260	1416	1.85	1475	2.15	1530	2.46	1584	2.78	1634	3.11	1685	3.45	1735	3.8	1783	4.16	1829	4.52
8400	2434	1525	2.31	1580	2.64	1632	2.97	1682	3.31	1730	3.66	1776	4.01	1824	4.38	1870	4.76	1915	5.14
9000	2608	1634	2.84	1686	3.19	1734	3.55	1782	3.91	1827	4.28	1871	4.65	1914	5.03	1959	5.43	2002	5.84
9600	2782	1743	3.45	1792	3.82	1838	4.2	1882	4.58	1926	4.97	1968	5.37	2008	5.77	2049	6.18	2091	6.61
10200	2956	1852	4.14	1898	4.53	1942	4.93	1984	5.34	2025	5.75	2066	6.17	2105	6.59	2142	7.02	2181	7.46
10800	3130	1961	4.91	2004	5.33	2046	5.75	2086	6.18	2125	6.62	2164	7.05	2202	7.5	2238	7.95	2274	8.4
11400	3304	2070	5.77	2111	6.22	2151	6.66	2189	7.12	2226	7.57	2264	8.03	2300	8.5	2335	8.97		
12000	3478	2179	6.73	2218	7.2	2256	7.67	2293	8.14	2328	8.62								

CFM	OV	STATIC PRESSURE (in. wg)																	
		1.50		2.00		2.50		3.00		3.50		4.00		4.50		5.00		5.50	
		RPM	BHP	RPM	BHP	RPM	BHP	RPM	BHP	RPM	BHP	RPM	BHP	RPM	BHP	RPM	BHP	RPM	BHP
4000	1159	1239	1.38	1377	1.85	1515	2.35	1643	2.89										
4400	1275	1275	1.53	1412	2.02	1533	2.54	1660	3.11	1778	3.69								
4800	1391	1322	1.72	1447	2.21	1568	2.76	1678	3.33	1795	3.94	1905	4.58						
5200	1507	1371	1.93	1486	2.43	1603	2.99	1713	3.59	1814	4.21	1922	4.87	2025	5.55	2123	6.25		
5600	1623	1422	2.16	1534	2.69	1639	3.24	1748	3.87	1848	4.51	1942	5.18	2042	5.88	2140	6.61	2233	7.35
6000	1739	1477	2.41	1583	2.97	1683	3.54	1784	4.16	1884	4.83	1977	5.52	2066	6.23	2157	6.98	2250	7.75
6400	1855	1533	2.68	1633	3.27	1731	3.87	1824	4.49	1920	5.17	2013	5.89	2100	6.63	2184	7.38	2267	8.16
6800	1971	1590	2.97	1688	3.6	1781	4.23	1871	4.88	1957	5.53	2048	6.27	2136	7.04	2219	7.82	2298	8.62
7200	2086	1647	3.28	1744	3.94	1832	4.62	1921	5.29	2004	5.98	2085	6.68	2172	7.47	2254	8.28	2333	9.11
7600	2202	1705	3.62	1800	4.32	1887	5.02	1970	5.74	2052	6.45	2131	7.17	2208	7.93	2290	8.77		
8000	2318	1764	3.98	1857	4.72	1943	5.46	2022	6.2	2102	6.95	2179	7.71	2253	8.47	2326	9.27		
8400	2434	1824	4.38	1915	5.14	1999	5.92	2077	6.7	2152	7.49	2228	8.27	2301	9.07				
8800	2550	1884	4.81	1973	5.6	2056	6.41	2133	7.22	2206	8.04	2277	8.87	2350	9.69				
9200	2666	1945	5.27	2032	6.09	2113	6.93	2189	7.78	2262	8.63	2330	9.49						
9600	2782	2008	5.77	2091	6.61	2171	7.48	2246	8.37	2317	9.25								
10000	2898	2072	6.31	2151	7.16	2229	8.07	2303	8.98										

Performance shown is for model LSF with outlet duct. Power ratings (Bhp) do not include transmission losses.

Maximum rpm	2179
Maximum Motor Frame Size	254T
Minimum Motor Size	3/4 [hp]
Maximum Motor Size	15 [hp]
Wheel Diameter	20.00 [in.] 508 [mm]
Outlet Area	4.14 [ft ²] 0.385 [m ²]
Outlet Velocity	cfm / 4.14 [ft/min] m ³ /s / 0.385 [m/s]
Peak Power	(rpm / 972) ³ [ft/min] (rpm / 1072) ³ [m/s]
Tip Speed	rpm x 5.24 [ft/min] rpm x 0.0266 [m/s]

Imperial data – Metric data

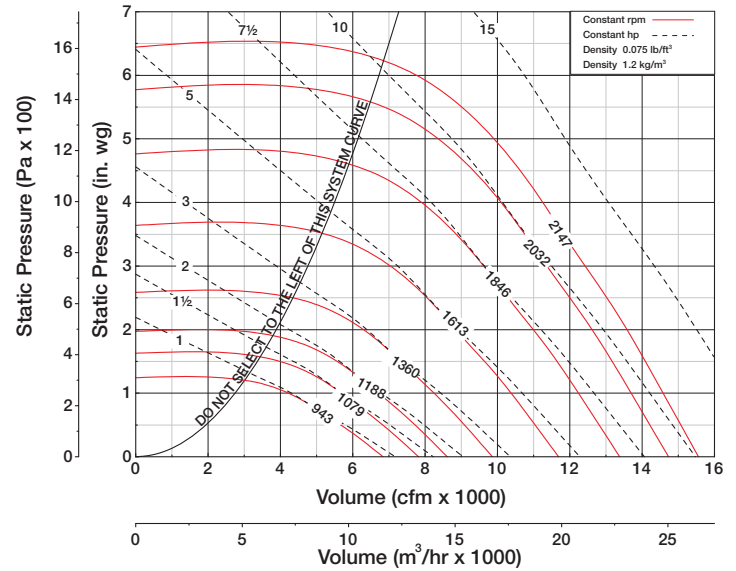

CFM	OV	STATIC PRESSURE (in. wg)																	
		0.00		0.25		0.50		0.75		1.00		1.25		1.50		1.75		2.00	
		RPM	BHP	RPM	BHP	RPM	BHP	RPM	BHP	RPM	BHP	RPM	BHP	RPM	BHP	RPM	BHP	RPM	BHP
3000	724	414	0.07	557	0.2	668	0.35	773	0.52	873	0.71								
3800	917	524	0.15	644	0.31	741	0.48	828	0.66	915	0.87	993	1.1	1073	1.34	1149	1.59		
4600	1111	635	0.26	735	0.45	825	0.66	902	0.87	975	1.09	1047	1.33	1117	1.59	1182	1.86	1246	2.14
5400	1304	745	0.43	833	0.64	913	0.88	986	1.12	1050	1.38	1114	1.63	1173	1.89	1236	2.18	1296	2.48
6200	1497	855	0.64	934	0.89	1004	1.15	1072	1.43	1134	1.71	1191	2	1247	2.29	1301	2.59	1352	2.89
7000	1690	966	0.93	1036	1.2	1100	1.49	1162	1.79	1221	2.11	1276	2.44	1327	2.76	1376	3.09	1426	3.42
7800	1884	1076	1.28	1140	1.59	1199	1.9	1253	2.23	1310	2.58	1362	2.93	1411	3.3	1458	3.65	1502	4.02
8600	2077	1186	1.72	1245	2.06	1299	2.4	1350	2.75	1400	3.12	1451	3.51	1498	3.9	1543	4.3	1586	4.7
9400	2270	1297	2.24	1351	2.61	1401	2.99	1449	3.37	1495	3.76	1541	4.17	1587	4.59	1630	5.02	1672	5.46
10200	2463	1407	2.86	1457	3.27	1504	3.67	1549	4.08	1592	4.5	1634	4.92	1677	5.37	1719	5.83	1760	6.3
11000	2657	1518	3.59	1564	4.02	1608	4.46	1650	4.9	1691	5.35	1731	5.8	1769	6.26	1809	6.75	1848	7.25
11800	2850	1628	4.44	1671	4.9	1713	5.37	1752	5.84	1791	6.32	1829	6.8	1866	7.28	1901	7.78	1939	8.3
12600	3043	1738	5.4	1779	5.89	1818	6.39	1856	6.9	1892	7.4	1929	7.91	1964	8.43	1997	8.95	2031	9.48
13400	3236	1849	6.49	1887	7.02	1924	7.55	1960	8.08	1994	8.62	2029	9.16	2062	9.71	2095	10.26	2127	10.81
14200	3429	1959	7.73	1995	8.28	2031	8.84	2064	9.41	2097	9.98	2130	10.55						
15000	3623	2069	9.11	2104	9.7	2137	10.29												

CFM	OV	STATIC PRESSURE (in. wg)																	
		1.50		2.00		2.50		3.00		3.50		4.00		4.50		5.00		5.50	
		RPM	BHP	RPM	BHP	RPM	BHP	RPM	BHP	RPM	BHP	RPM	BHP	RPM	BHP	RPM	BHP	RPM	BHP
5000	1207	1144	1.73	1269	2.3	1389	2.92	1506	3.57										
5500	1328	1182	1.94	1303	2.53	1413	3.17	1522	3.85	1630	4.57	1730	5.31						
6000	1449	1228	2.19	1337	2.78	1447	3.45	1546	4.15	1646	4.89	1746	5.67	1840	6.47				
6500	1570	1275	2.46	1379	3.08	1480	3.75	1580	4.48	1672	5.24	1762	6.04	1856	6.87	1945	7.73	2030	8.61
7000	1690	1327	2.76	1426	3.42	1518	4.09	1614	4.84	1705	5.63	1791	6.45	1873	7.29	1962	8.19	2046	9.1
7500	1811	1379	3.09	1472	3.79	1563	4.49	1648	5.22	1739	6.05	1824	6.9	1904	7.77	1980	8.67	2063	9.61
8000	1932	1433	3.44	1523	4.18	1610	4.93	1692	5.69	1773	6.48	1858	7.37	1938	8.28	2014	9.21	2086	10.15
8500	2053	1487	3.82	1576	4.61	1657	5.4	1738	6.2	1815	7.01	1892	7.87	1972	8.81	2047	9.77	2119	10.76
9000	2173	1542	4.23	1629	5.07	1709	5.9	1786	6.74	1861	7.59	1933	8.45	2006	9.37	2081	10.37		
9500	2294	1598	4.68	1683	5.56	1761	6.43	1834	7.32	1908	8.21	1978	9.11	2046	10.02	2115	10.99		
10000	2415	1654	5.17	1738	6.08	1815	7.01	1887	7.93	1955	8.87	2025	9.81	2091	10.75				
10500	2536	1711	5.69	1793	6.64	1869	7.62	1939	8.58	2006	9.56	2072	10.55	2138	11.53				
11000	2657	1769	6.26	1848	7.25	1923	8.26	1993	9.28	2059	10.29	2121	11.32						
11500	2777	1829	6.89	1905	7.89	1978	8.94	2047	10.01	2112	11.07								
12000	2898	1890	7.56	1962	8.59	2033	9.67	2101	10.77										
12500	3019	1951	8.28	2019	9.33	2089	10.45												

Performance shown is for model LSF with outlet duct. Power ratings (Bhp) do not include transmission losses.

Maximum rpm	1959
Maximum Motor Frame Size	254T
Minimum Motor Size	1 [hp]
Maximum Motor Size	15 [hp]
Wheel Diameter	22.25 [in.] 565 [mm]
Outlet Area	5.12 [ft ²] 0.476 [m ²]
Outlet Velocity	cfm / 5.12 [ft/min] m ³ /s / 0.476 [m/s]
Peak Power	(rpm / 811) ³ [ft/min] (rpm / 894) ³ [m/s]
Tip Speed	rpm x 5.83 [ft/min] rpm x 0.0296 [m/s]

Imperial data – Metric data

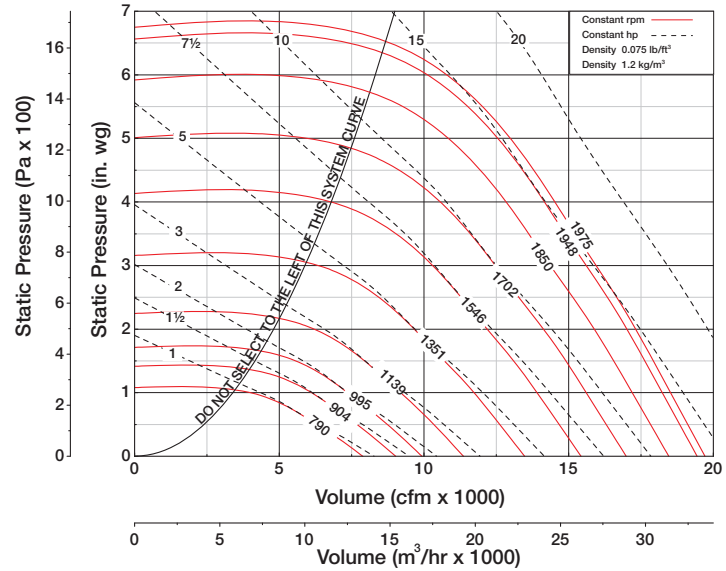

CFM	OV	STATIC PRESSURE (in. wg)																	
		0.00		0.25		0.50		0.75		1.00		1.25		1.50		1.75		2.00	
		RPM	BHP	RPM	BHP	RPM	BHP	RPM	BHP	RPM	BHP	RPM	BHP	RPM	BHP	RPM	BHP	RPM	BHP
4000	781	401	0.11	523	0.28	618	0.47	708	0.69	792	0.93	874	1.19						
5000	976	501	0.22	603	0.43	688	0.66	763	0.89	837	1.15	907	1.44	972	1.74	1040	2.06	1104	2.39
6000	1171	601	0.38	688	0.62	766	0.89	834	1.17	897	1.45	956	1.74	1019	2.07	1077	2.42	1132	2.77
7000	1367	701	0.6	778	0.88	847	1.18	911	1.51	968	1.83	1023	2.16	1075	2.49	1127	2.84	1180	3.23
8000	1562	802	0.9	869	1.22	930	1.55	990	1.91	1045	2.28	1096	2.65	1143	3.02	1191	3.4	1236	3.78
9000	1757	902	1.28	963	1.64	1019	2.01	1072	2.39	1124	2.8	1173	3.22	1218	3.63	1261	4.05	1304	4.47
10000	1953	1002	1.76	1058	2.16	1109	2.56	1157	2.97	1205	3.41	1252	3.87	1296	4.33	1337	4.79	1377	5.26
11000	2148	1102	2.34	1153	2.78	1201	3.22	1246	3.67	1288	4.13	1333	4.62	1375	5.12	1415	5.63	1454	6.14
12000	2343	1203	3.04	1249	3.52	1293	4	1336	4.48	1376	4.98	1416	5.49	1456	6.03	1495	6.57	1532	7.13
13000	2539	1303	3.87	1346	4.38	1387	4.9	1427	5.42	1465	5.96	1502	6.5	1539	7.06	1576	7.64	1612	8.23
14000	2734	1403	4.83	1444	5.38	1482	5.94	1519	6.5	1555	7.07	1590	7.65	1624	8.23	1658	8.84	1693	9.47
15000	2929	1503	5.95	1541	6.53	1577	7.13	1612	7.73	1647	8.34	1680	8.95	1712	9.57	1743	10.19	1776	10.85
16000	3125	1603	7.22	1639	7.84	1673	8.48	1706	9.12	1739	9.76	1771	10.41	1801	11.07	1831	11.73	1861	12.39
17000	3320	1704	8.65	1737	9.32	1770	9.99	1801	10.67	1832	11.35	1862	12.04	1892	12.73	1921	13.43	1949	14.14
18000	3515	1804	10.3	1836	11	1867	11.7	1897	12.4	1926	13.1	1954	13.9						
19000	3710	1904	12.1	1934	12.8	1964	13.6												

CFM	OV	STATIC PRESSURE (in. wg)																	
		1.50		2.00		2.50		3.00		3.50		4.00		4.50		5.00		5.50	
		RPM	BHP	RPM	BHP	RPM	BHP	RPM	BHP	RPM	BHP	RPM	BHP	RPM	BHP	RPM	BHP	RPM	BHP
7000	1367	1075	2.49	1180	3.23	1279	4.03	1373	4.87	1469	5.78	1559	6.71						
7600	1484	1116	2.8	1210	3.53	1309	4.37	1398	5.25	1484	6.16	1574	7.14	1658	8.15	1738	9.18		
8200	1601	1157	3.14	1250	3.91	1338	4.74	1428	5.66	1510	6.61	1587	7.59	1672	8.64	1752	9.71	1828	10.81
8800	1718	1203	3.5	1291	4.33	1373	5.17	1457	6.09	1539	7.09	1616	8.11	1688	9.15	1767	10.26	1843	11.4
9400	1835	1249	3.9	1331	4.78	1413	5.66	1488	6.56	1569	7.59	1645	8.65	1717	9.74	1786	10.85	1857	12.01
10000	1953	1296	4.33	1377	5.26	1454	6.19	1528	7.14	1599	8.12	1675	9.22	1747	10.35	1815	11.51	1880	12.69
10600	2070	1343	4.79	1423	5.77	1495	6.77	1569	7.76	1637	8.77	1705	9.82	1776	11	1844	12.19	1909	13.41
11200	2187	1391	5.29	1469	6.33	1541	7.37	1609	8.42	1677	9.47	1741	10.54	1806	11.67	1874	12.91	1938	14.17
11800	2304	1440	5.84	1516	6.92	1587	8.01	1652	9.11	1718	10.22	1781	11.33	1842	12.47	1903	13.66	1968	14.97
12400	2421	1489	6.42	1564	7.55	1633	8.7	1698	9.85	1759	11.02	1822	12.17	1882	13.35	1939	14.54		
13000	2539	1539	7.06	1612	8.23	1680	9.43	1744	10.63	1804	11.84	1863	13.06	1923	14.28				
13600	2656	1589	7.74	1660	8.96	1727	10.2	1790	11.46	1849	12.71	1906	13.99	1963	15.27				
14200	2773	1641	8.49	1710	9.73	1775	11.02	1837	12.34	1896	13.64	1951	14.96						
14800	2890	1694	9.29	1759	10.56	1824	11.89	1884	13.25	1942	14.63								
15400	3007	1748	10.1	1809	11.4	1872	12.8	1932	14.2										
16000	3125	1801	11.1	1861	12.4	1922	13.8												

Performance shown is for model LSF with outlet duct. Power ratings (Bhp) do not include transmission losses.

Maximum rpm	1776
Maximum Motor Frame Size	256T
Minimum Motor Size	1 [hp]
Maximum Motor Size	20 [hp]
Wheel Diameter	24.50 [in.] 622 [mm]
Outlet Area	6.21 [ft ²] 0.577 [m ²]
Outlet Velocity	cfm / 6.21 [ft/min] m ³ /s / 0.577 [m/s]
Peak Power	(rpm / 701) ³ [ft/min] (rpm / 773) ³ [m/s]
Tip Speed	rpm x 6.41 [ft/min] rpm x 0.0326 [m/s]

Imperial data – Metric data

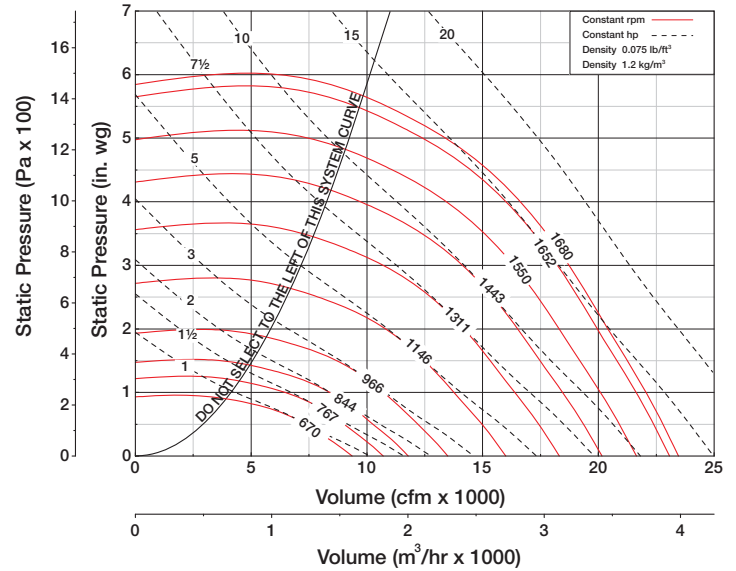

CFM	OV	STATIC PRESSURE (in. wg)																	
		0.00		0.25		0.50		0.75		1.00		1.25		1.50		1.75		2.00	
		RPM	BHP	RPM	BHP	RPM	BHP	RPM	BHP	RPM	BHP	RPM	BHP	RPM	BHP	RPM	BHP	RPM	BHP
5000	805	358	0.12	464	0.33	557	0.56	647	0.83	726	1.12	800	1.43						
6200	998	444	0.23	532	0.48	609	0.75	685	1.05	759	1.37	827	1.72	891	2.08	952	2.46	1010	2.85
7400	1191	530	0.39	605	0.69	673	1	738	1.33	802	1.68	863	2.06	924	2.46	981	2.87	1034	3.3
8600	1384	616	0.61	682	0.96	742	1.32	800	1.69	854	2.06	910	2.47	963	2.89	1017	3.34	1069	3.81
9800	1578	702	0.91	759	1.29	815	1.71	865	2.13	916	2.54	963	2.96	1013	3.43	1061	3.9	1106	4.39
11000	1771	788	1.28	838	1.71	890	2.18	937	2.64	982	3.11	1027	3.57	1069	4.05	1114	4.55	1157	5.08
12200	1964	874	1.75	919	2.21	966	2.73	1010	3.25	1051	3.76	1092	4.28	1133	4.79	1171	5.32	1210	5.86
13400	2157	959	2.32	1001	2.83	1044	3.38	1085	3.96	1124	4.52	1161	5.08	1198	5.65	1236	6.22	1271	6.79
14600	2351	1045	3	1084	3.55	1122	4.13	1162	4.76	1199	5.39	1234	6	1267	6.62	1301	7.24	1336	7.85
15800	2544	1131	3.8	1167	4.4	1202	5.01	1239	5.68	1274	6.37	1307	7.03	1340	7.7	1371	8.37	1402	9.04
17000	2737	1217	4.73	1251	5.37	1283	6.03	1317	6.73	1350	7.46	1382	8.21	1413	8.91	1443	9.62	1472	10.35
18200	2930	1303	5.81	1335	6.49	1365	7.19	1396	7.93	1427	8.7	1458	9.49	1488	10.27	1516	11.03	1544	11.79
19400	3123	1389	7.03	1419	7.76	1447	8.51	1475	9.27	1505	10.09	1535	10.92	1563	11.76	1591	12.59	1618	13.39
20600	3317	1475	8.42	1503	9.2	1530	9.98	1556	10.78	1584	11.63	1612	12.51	1640	13.39	1666	14.29		
21800	3510	1561	9.98	1587	10.8	1613	11.63	1638	12.47	1663	13.34								
23000	3703	1647	11.7	1672	12.6														

CFM	OV	STATIC PRESSURE (in. wg)																	
		1.50		2.00		2.50		3.00		3.50		4.00		4.50		5.00		5.50	
		RPM	BHP	RPM	BHP	RPM	BHP	RPM	BHP	RPM	BHP	RPM	BHP	RPM	BHP	RPM	BHP	RPM	BHP
7000	1127	912	2.33	1025	3.15	1130	4.02												
7800	1256	936	2.6	1045	3.46	1146	4.38	1241	5.35	1328	6.36								
8600	1384	963	2.89	1069	3.81	1165	4.78	1256	5.8	1343	6.86	1425	7.95						
9400	1513	996	3.24	1093	4.18	1189	5.21	1276	6.27	1359	7.38	1440	8.53	1517	9.71	1589	10.92		
10200	1642	1032	3.62	1123	4.61	1213	5.66	1299	6.78	1379	7.93	1456	9.13	1532	10.37	1604	11.64	1673	12.93
11000	1771	1069	4.05	1157	5.08	1239	6.16	1323	7.32	1403	8.53	1477	9.77	1548	11.05	1620	12.37		
11800	1900	1111	4.53	1192	5.59	1272	6.73	1347	7.89	1427	9.16	1501	10.46	1571	11.79	1637	13.14		
12600	2028	1155	5.07	1229	6.15	1306	7.33	1380	8.56	1451	9.82	1525	11.18	1595	12.56	1661	13.97		
13400	2157	1198	5.65	1271	6.79	1342	7.99	1414	9.27	1482	10.57	1549	11.93	1619	13.37				
14200	2286	1243	6.29	1314	7.48	1380	8.71	1449	10.02	1516	11.39	1579	12.78	1643	14.22				
15000	2415	1291	6.96	1358	8.23	1422	9.51	1484	10.83	1550	12.25	1613	13.7	1672	15.17				
15800	2544	1340	7.7	1402	9.04	1465	10.37	1525	11.73	1585	13.16	1647	14.67						
16600	2673	1389	8.49	1448	9.9	1509	11.3	1567	12.71	1622	14.15								
17400	2801	1438	9.35	1496	10.81	1553	12.29	1610	13.76	1664	15.25								
18200	2930	1488	10.3	1544	11.8	1597	13.3	1654	14.9										
19000	3059	1538	11.3	1593	12.8	1645	14.5												

Performance shown is for model LSF with outlet duct. Power ratings (Bhp) do not include transmission losses.

Maximum rpm	1611
Maximum Motor Frame Size	256T
Minimum Motor Size	1½ [hp]
Maximum Motor Size	20 [hp]
Wheel Diameter	27.00 [in.] 686 [mm]
Outlet Area	7.54 [ft²] 0.700 [m²]
Outlet Velocity	cfm / 7.54 [ft/min] m³/s / 0.700 [m/s]
Peak Power	(rpm / 605)³ [ft/min] (rpm / 667)³ [m/s]
Tip Speed	rpm x 7.07 [ft/min] rpm x 0.0359 [m/s]

Imperial data – Metric data

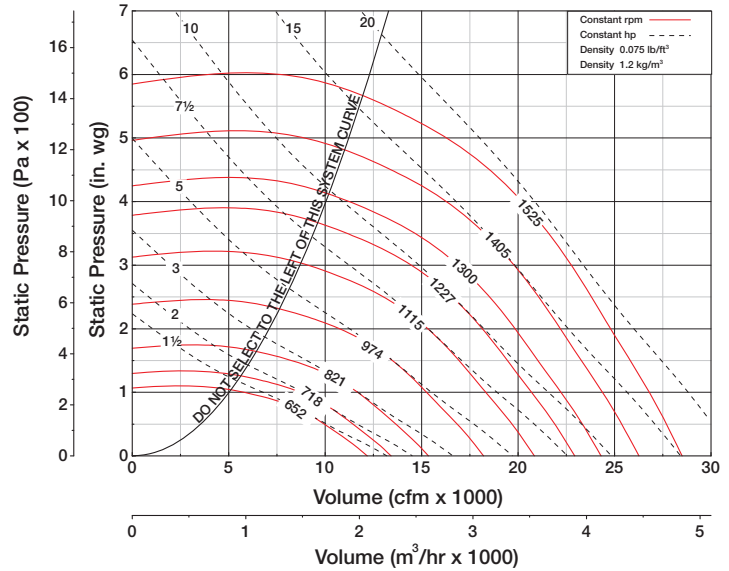

CFM	OV	STATIC PRESSURE (in. wg)																	
		0.00		0.25		0.50		0.75		1.00		1.25		1.50		1.75		2.00	
		RPM	BHP	RPM	BHP	RPM	BHP	RPM	BHP	RPM	BHP	RPM	BHP	RPM	BHP	RPM	BHP	RPM	BHP
5000	663	267	0.08	380	0.29	480	0.55	567	0.85										
6500	862	348	0.18	438	0.45	519	0.74	596	1.08	666	1.45	732	1.84	793	2.25				
8000	1061	428	0.33	504	0.66	571	1	637	1.38	700	1.78	761	2.22	817	2.67	871	3.14	923	3.64
9500	1259	508	0.56	573	0.95	632	1.35	688	1.75	744	2.2	796	2.66	850	3.16	901	3.68	949	4.22
11000	1458	588	0.87	645	1.31	698	1.77	748	2.24	796	2.71	844	3.22	891	3.75	935	4.3	982	4.88
12500	1657	669	1.28	718	1.76	767	2.3	811	2.83	856	3.35	898	3.89	940	4.45	982	5.05	1022	5.66
14000	1856	749	1.79	793	2.33	838	2.92	879	3.52	918	4.11	958	4.7	995	5.3	1031	5.91	1071	6.57
15500	2055	829	2.43	869	3.02	910	3.67	949	4.33	985	4.98	1019	5.64	1056	6.29	1090	6.95	1123	7.63
17000	2254	909	3.21	946	3.85	983	4.54	1019	5.27	1054	5.99	1086	6.71	1118	7.44	1151	8.15	1183	8.87
18500	2453	990	4.13	1023	4.83	1056	5.56	1091	6.35	1123	7.16	1155	7.93	1184	8.71	1213	9.5	1244	10.27
20000	2652	1070	5.22	1101	5.98	1131	6.75	1163	7.59	1194	8.45	1224	9.32	1253	10.15	1280	10.99	1307	11.85
21500	2851	1150	6.49	1179	7.3	1207	8.13	1237	9	1266	9.92	1295	10.86	1322	11.77	1348	12.67	1374	13.57
23000	3050	1230	7.94	1258	8.81	1284	9.69	1311	10.6	1339	11.58	1366	12.57	1392	13.57	1417	14.54	1442	15.49
24500	3249	1311	9.6	1337	10.52	1361	11.46	1385	12.41	1412	13.43	1438	14.48	1463	15.54	1487	16.61	1511	17.63
26000	3448	1391	11.5	1415	12.5	1439	13.4	1462	14.4	1486	15.5	1511	16.6						
27500	3647	1471	13.6	1494	14.6	1517	15.7												

CFM	OV	STATIC PRESSURE (in. wg)																	
		1.50		2.00		2.50		3.00		3.50		4.00		4.50		5.00		5.50	
		RPM	BHP	RPM	BHP	RPM	BHP	RPM	BHP	RPM	BHP	RPM	BHP	RPM	BHP	RPM	BHP	RPM	BHP
11000	1458	891	3.75	982	4.88	1069	6.1	1148	7.36	1227	8.69	1301	10.05	1370	11.46				
11800	1564	916	4.11	1001	5.27	1087	6.54	1166	7.85	1239	9.22	1312	10.64	1382	12.11	1447	13.6	1510	15.14
12600	1671	943	4.51	1026	5.72	1105	7	1184	8.37	1256	9.79	1324	11.25	1393	12.77	1459	14.33	1521	15.92
13400	1777	972	4.94	1051	6.19	1125	7.51	1202	8.92	1274	10.39	1341	11.9	1405	13.45	1470	15.07		
14200	1883	1003	5.42	1078	6.7	1150	8.07	1220	9.49	1292	11.02	1359	12.59	1423	14.19	1483	15.83		
15000	1989	1035	5.95	1104	7.25	1176	8.67	1243	10.13	1310	11.67	1377	13.3	1440	14.96	1500	16.65		
15800	2095	1068	6.51	1135	7.86	1202	9.31	1268	10.82	1330	12.38	1395	14.03	1458	15.75	1518	17.51		
16600	2201	1101	7.12	1167	8.52	1228	9.98	1293	11.55	1355	13.16	1413	14.81	1476	16.58				
17400	2307	1135	7.76	1199	9.23	1258	10.73	1320	12.32	1380	13.99	1438	15.69	1494	17.44				
18200	2413	1171	8.44	1231	9.98	1290	11.53	1346	13.13	1406	14.86	1463	16.61	1517	18.4				
19000	2519	1207	9.17	1264	10.78	1322	12.39	1376	14.03	1432	15.77	1488	17.58						
19800	2625	1244	9.94	1298	11.63	1354	13.3	1408	14.99	1459	16.72	1515	18.59						
20600	2732	1280	10.8	1333	12.5	1387	14.3	1440	16	1489	17.8								
21400	2838	1317	11.7	1369	13.5	1420	15.3	1472	17.1	1521	18.9								
22200	2944	1355	12.6	1406	14.4	1454	16.3	1504	18.2										
23000	3050	1392	13.6	1442	15.5	1489	17.4												

Performance shown is for model LSF with outlet duct. Power ratings (Bhp) do not include transmission losses.

Maximum rpm	1348
Maximum Motor Frame Size	284T
Minimum Motor Size	2 [hp]
Maximum Motor Size	25 [hp]
Wheel Diameter	30.00 [in.] 762 [mm]
Outlet Area	9.31 [ft ²] 0.865 [m ²]
Outlet Velocity	cfm / 9.31 [ft/min] m ³ /s / 0.865 [m/s]
Peak Power	(rpm / 485) ³ [ft/min] (rpm / 535) ³ [m/s]
Tip Speed	rpm x 7.85 [ft/min] rpm x 0.0399 [m/s]

Imperial data – Metric data

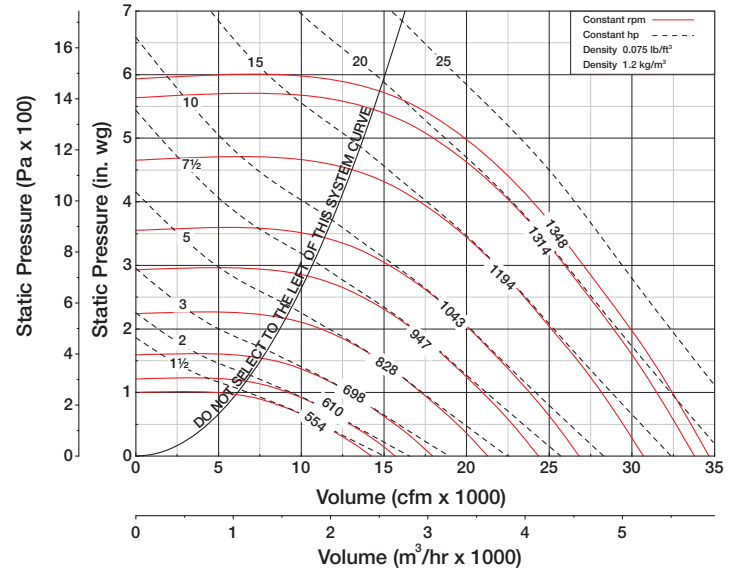

CFM	OV	STATIC PRESSURE (in. wg)																	
		0.00		0.25		0.50		0.75		1.00		1.25		1.50		1.75		2.00	
		RPM	BHP	RPM	BHP	RPM	BHP	RPM	BHP	RPM	BHP	RPM	BHP	RPM	BHP	RPM	BHP	RPM	BHP
10000	1074	389	0.44	459	0.83	520	1.23	574	1.66	625	2.14	677	2.67	724	3.22	768	3.79	811	4.38
11500	1235	447	0.67	508	1.12	564	1.57	615	2.04	661	2.54	707	3.09	752	3.68	795	4.3	835	4.93
13000	1396	506	0.97	559	1.48	611	1.98	658	2.5	702	3.03	743	3.61	784	4.22	822	4.86	863	5.54
14500	1557	564	1.35	612	1.91	660	2.47	704	3.04	745	3.62	783	4.22	820	4.86	858	5.54	893	6.24
16000	1718	622	1.81	667	2.43	710	3.05	751	3.67	790	4.31	827	4.95	862	5.61	895	6.3	929	7.05
17500	1879	681	2.37	722	3.04	761	3.73	800	4.4	837	5.09	871	5.79	905	6.49	937	7.21	967	7.94
19000	2040	739	3.03	777	3.76	812	4.51	850	5.24	885	5.98	917	6.73	949	7.49	980	8.25	1010	9.03
20500	2201	797	3.81	833	4.59	866	5.39	900	6.19	933	6.98	965	7.78	995	8.6	1025	9.42	1054	10.24
22000	2363	856	4.71	889	5.55	920	6.4	951	7.27	983	8.11	1014	8.96	1043	9.83	1070	10.71	1098	11.58
23500	2524	914	5.74	945	6.63	975	7.54	1003	8.47	1033	9.37	1063	10.28	1091	11.2	1118	12.12	1144	13.06
25000	2685	973	6.91	1002	7.86	1030	8.82	1057	9.81	1084	10.78	1113	11.74	1140	12.71	1166	13.69	1191	14.67
26500	2846	1031	8.23	1059	9.23	1085	10.25	1111	11.29	1135	12.34	1163	13.35	1189	14.37	1215	15.4	1239	16.44
28000	3007	1089	9.7	1116	10.77	1141	11.84	1165	12.94	1189	14.04	1214	15.13	1239	16.2	1264	17.28	1288	18.37
29500	3168	1148	11.3	1173	12.5	1197	13.6	1220	14.7	1243	15.9	1265	17.1	1290	18.2	1314	19.3	1337	20.5
31000	3329	1206	13.2	1230	14.3	1253	15.5	1276	16.7	1297	17.9	1318	19.2	1341	20.4				
32500	3490	1264	15.2	1287	16.4	1310	17.6	1331	18.9										

CFM	OV	STATIC PRESSURE (in. wg)																	
		1.50		2.00		2.50		3.00		3.50		4.00		4.50		5.00		5.50	
		RPM	BHP	RPM	BHP	RPM	BHP	RPM	BHP	RPM	BHP	RPM	BHP	RPM	BHP	RPM	BHP	RPM	BHP
12500	1342	772	4.03	854	5.33	928	6.72	996	8.18	1064	9.71	1128	11.3						
13500	1450	796	4.43	872	5.76	946	7.21	1013	8.73	1076	10.31	1139	11.96	1199	13.66				
14500	1557	820	4.86	893	6.24	964	7.73	1031	9.31	1092	10.95	1151	12.65	1210	14.41	1267	16.22	1320	18.08
15500	1664	847	5.34	917	6.77	982	8.27	1049	9.92	1110	11.62	1168	13.38	1222	15.19	1278	17.06	1332	18.98
16500	1772	876	5.89	941	7.34	1005	8.9	1068	10.56	1129	12.32	1186	14.14	1240	16.01	1291	17.93	1343	19.91
17500	1879	905	6.49	967	7.94	1030	9.58	1088	11.26	1147	13.06	1204	14.94	1258	16.87	1309	18.85		
18500	1987	935	7.14	996	8.66	1054	10.29	1112	12.04	1166	13.84	1222	15.78	1276	17.77	1327	19.81		
19500	2094	965	7.84	1024	9.42	1080	11.05	1136	12.87	1189	14.73	1241	16.65	1294	18.71	1345	20.81		
20500	2201	995	8.6	1054	10.24	1108	11.93	1160	13.74	1213	15.66	1263	17.64	1313	19.68				
21500	2309	1027	9.4	1083	11.12	1137	12.87	1186	14.66	1238	16.65	1287	18.69	1334	20.77				
22500	2416	1059	10.3	1113	12.1	1166	13.9	1215	15.7	1262	17.7	1311	19.8						
23500	2524	1091	11.2	1144	13.1	1195	14.9	1244	16.9	1289	18.8	1336	20.9						
24500	2631	1123	12.2	1175	14.1	1225	16.1	1273	18.1	1318	20.1								
25500	2738	1156	13.2	1207	15.2	1255	17.3	1302	19.3	1347	21.4								
26500	2846	1189	14.4	1239	16.4	1286	18.5	1332	20.7										
27500	2953	1223	15.6	1271	17.7	1317	19.9												

Performance shown is for model LSF with outlet duct. Power ratings (Bhp) do not include transmission losses.

Maximum rpm	1225
Maximum Motor Frame Size	286T
Minimum Motor Size	2 [hp]
Maximum Motor Size	30 [hp]
Wheel Diameter	33.00 [in.] 838 [mm]
Outlet Area	11.3 [ft ²] 1.05 [m ²]
Outlet Velocity	cfm / 11.27 [ft/min] m ³ /s / 1.05 [m/s]
Peak Power	(rpm / 404) ³ [ft/min] (rpm / 446) ³ [m/s]
Tip Speed	rpm x 8.64 [ft/min] rpm x 0.0439 [m/s]

Imperial data – Metric data

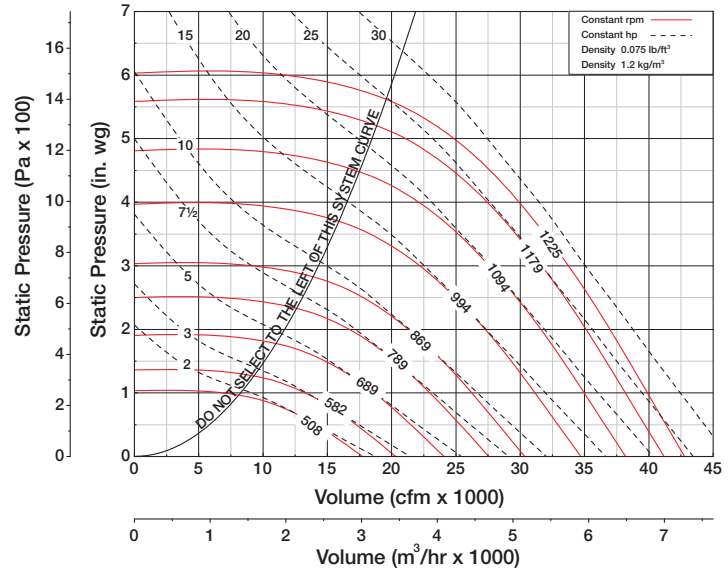

CFM	OV	STATIC PRESSURE (in. wg)																	
		0.00		0.25		0.50		0.75		1.00		1.25		1.50		1.75		2.00	
		RPM	BHP	RPM	BHP	RPM	BHP	RPM	BHP	RPM	BHP	RPM	BHP	RPM	BHP	RPM	BHP	RPM	BHP
10000	887	286	0.3	359	0.71	423	1.14	479	1.63	534	2.17	585	2.76						
12000	1064	344	0.53	407	1	462	1.49	512	2.04	561	2.62	607	3.23	651	3.91	694	4.62	736	5.39
14000	1242	401	0.84	457	1.39	505	1.96	551	2.54	595	3.18	636	3.85	676	4.55	716	5.28	754	6.07
16000	1419	458	1.25	508	1.88	552	2.52	594	3.18	634	3.85	672	4.58	708	5.34	744	6.12	779	6.92
18000	1597	515	1.78	561	2.49	601	3.2	638	3.93	675	4.67	711	5.43	745	6.25	776	7.09	810	7.95
20000	1774	573	2.44	614	3.22	651	4.02	685	4.82	719	5.64	752	6.46	784	7.3	815	8.2	845	9.12
22000	1952	630	3.24	668	4.11	702	4.99	734	5.85	766	6.74	796	7.66	826	8.55	855	9.46	884	10.45
24000	2129	687	4.21	722	5.16	754	6.11	785	7.06	813	8.01	842	8.99	869	9.99	897	10.96	924	11.95
26000	2307	744	5.35	777	6.38	807	7.4	836	8.44	863	9.47	889	10.51	915	11.58	941	12.66	966	13.71
28000	2484	802	6.69	832	7.79	861	8.89	888	10.01	913	11.12	938	12.22	963	13.35	987	14.51	1010	15.67
30000	2661	859	8.22	888	9.4	914	10.59	940	11.78	964	12.98	988	14.16	1011	15.35	1034	16.56	1057	17.8
32000	2839	916	9.98	943	11.23	969	12.51	993	13.77	1016	15.05	1039	16.31	1061	17.57	1082	18.85	1104	20.15
34000	3016	974	12	999	13.3	1023	14.7	1046	16	1069	17.3	1090	18.7	1111	20	1132	21.4	1152	22.7
36000	3194	1031	14.2	1055	15.6	1078	17	1100	18.5	1121	19.9	1142	21.3	1162	22.8	1182	24.2	1201	25.6
38000	3371	1088	16.7	1111	18.2	1133	19.7	1154	21.2	1174	22.7	1194	24.2	1214	25.7				
40000	3549	1145	19.5	1167	21.1	1188	22.6	1208	24.2										

CFM	OV	STATIC PRESSURE (in. wg)																	
		1.50		2.00		2.50		3.00		3.50		4.00		4.50		5.00		5.50	
		RPM	BHP	RPM	BHP	RPM	BHP	RPM	BHP	RPM	BHP	RPM	BHP	RPM	BHP	RPM	BHP	RPM	BHP
17500	1552	735	6.01	802	7.68	865	9.43	927	11.36	985	13.38	1044	15.57						
18500	1641	755	6.5	818	8.23	880	10.05	939	11.96	997	14.05	1051	16.21	1107	18.53	1159	20.92		
19500	1730	774	7.03	834	8.81	896	10.69	952	12.64	1009	14.73	1063	16.95	1114	19.25	1167	21.71	1217	24.22
20500	1818	794	7.59	855	9.44	911	11.37	968	13.39	1020	15.45	1074	17.73	1125	20.07	1174	22.51	1224	25.08
21500	1907	815	8.22	874	10.1	927	12.09	983	14.17	1035	16.3	1086	18.53	1137	20.94	1184	23.4		
22500	1996	837	8.89	893	10.8	947	12.86	999	14.99	1051	17.19	1100	19.44	1149	21.83	1196	24.36		
23500	2085	858	9.61	913	11.55	967	13.67	1015	15.84	1067	18.12	1115	20.44	1161	22.8	1208	25.35		
24500	2173	881	10.4	934	12.4	986	14.5	1035	16.8	1082	19.1	1130	21.5	1176	23.9	1219	26.4		
25500	2262	904	11.2	956	13.3	1006	15.4	1054	17.7	1099	20.1	1146	22.5	1192	25				
26500	2351	927	12	977	14.2	1026	16.4	1074	18.7	1119	21.2	1162	23.7	1207	26.2				
27500	2440	951	12.9	999	15.2	1047	17.4	1093	19.8	1138	22.3	1179	24.8	1223	27.5				
28500	2528	975	13.8	1022	16.2	1068	18.5	1113	20.9	1157	23.5	1199	26.1						
29500	2617	999	14.8	1045	17.2	1090	19.7	1134	22.1	1177	24.7	1218	27.4						
30500	2706	1024	15.9	1068	18.4	1112	20.9	1155	23.4	1196	26								
31500	2795	1048	17	1092	19.5	1134	22.1	1176	24.7	1217	27.3								
32500	2883	1073	18.2	1116	20.8	1157	23.5	1198	26.1										

Performance shown is for model LSF with outlet duct. Power ratings (Bhp) do not include transmission losses.

Maximum rpm	1108
Maximum Motor Frame Size	324T
Minimum Motor Size	3 [hp]
Maximum Motor Size	40 [hp]
Wheel Diameter	36.50 [in.] 927 [mm]
Outlet Area	13.8 [ft ²] 1.28 [m ²]
Outlet Velocity	cfm / 13.79 [ft/min] m ³ /s / 1.28 [m/s]
Peak Power	(rpm / 335) ³ [ft/min] (rpm / 369) ³ [m/s]
Tip Speed	rpm x 9.56 [ft/min] rpm x 0.0485 [m/s]

Imperial data – Metric data

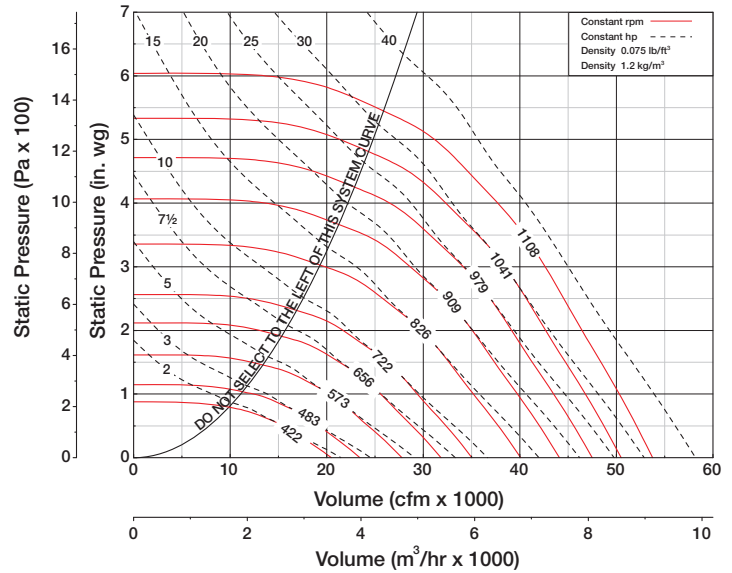

CFM	OV	STATIC PRESSURE (in. wg)																		
		0.00		0.25		0.50		0.75		1.00		1.25		1.50		1.75		2.00		
		RPM	BHP	RPM	BHP	RPM	BHP	RPM	BHP	RPM	BHP	RPM	BHP	RPM	BHP	RPM	BHP	RPM	BHP	
15000	1087	309	0.68	367	1.28	415	1.9	463	2.6	506	3.3	550	4.08	592	4.97	630	5.89			
17500	1269	361	1.09	411	1.78	454	2.48	496	3.23	537	4.06	575	4.88	610	5.71	649	6.68	684	7.72	
20000	1450	412	1.62	457	2.41	497	3.22	534	4.03	569	4.89	606	5.85	639	6.79	672	7.73	703	8.68	
22500	1631	464	2.31	504	3.18	541	4.11	574	5	607	5.94	638	6.91	671	7.97	702	9.05	732	10.09	
25000	1812	515	3.17	551	4.13	586	5.15	618	6.16	646	7.15	676	8.21	705	9.28	734	10.44	762	11.64	
27500	1994	567	4.22	600	5.27	632	6.38	662	7.51	689	8.6	715	9.7	743	10.87	769	12.05	794	13.28	
30000	2175	618	5.48	648	6.61	678	7.82	707	9.05	733	10.26	758	11.45	781	12.66	807	13.93	831	15.21	
32500	2356	670	6.97	698	8.18	725	9.48	752	10.8	778	12.15	801	13.44	824	14.73	845	16.04	869	17.41	
35000	2538	721	8.7	747	10.01	773	11.39	798	12.81	822	14.25	846	15.68	867	17.06	888	18.45	908	19.86	
37500	2719	773	10.7	797	12.1	821	13.6	844	15.1	868	16.6	890	18.2	911	19.7	931	21.1	951	22.6	
40000	2900	824	13	847	14.5	870	16	892	17.6	914	19.3	935	20.9	956	22.6	975	24.1	994	25.7	
42500	3081	876	15.6	897	17.2	918	18.8	940	20.5	960	22.2	981	23.9	1001	25.7	1020	27.5	1038	29.1	
45000	3263	927	18.5	948	20.2	967	21.9	988	23.7	1007	25.5	1027	27.3	1046	29.1	1065	31	1083	32.9	
47500	3444	979	21.7	998	23.5	1017	25.3	1036	27.2	1055	29.1	1073	31	1092	32.9					
50000	3625	1031	25.4	1049	27.2	1067	29.1	1085	31	1103	33									
52500	3807	1082	29.4	1100	31.3															

CFM	OV	STATIC PRESSURE (in. wg)																	
		1.50		2.00		2.50		3.00		3.50		4.00		4.50		5.00		5.50	
		RPM	BHP	RPM	BHP	RPM	BHP	RPM	BHP	RPM	BHP	RPM	BHP	RPM	BHP	RPM	BHP	RPM	BHP
20000	1450	639	6.79	703	8.68	768	10.98	828	13.42										
21500	1559	658	7.49	720	9.51	780	11.68	839	14.21	893	16.85								
23000	1667	677	8.21	737	10.39	793	12.56	850	15.04	904	17.77	955	20.59						
24500	1776	697	8.99	756	11.34	810	13.62	861	15.95	915	18.73	966	21.65	1014	24.65				
26000	1885	720	9.89	775	12.28	828	14.74	878	17.19	927	19.73	977	22.75	1025	25.84	1070	29.03		
27500	1994	743	10.9	794	13.3	847	15.9	896	18.5	942	21.1	988	23.9	1036	27.1	1081	30.4		
29000	2102	766	11.9	816	14.4	866	17.1	914	19.9	959	22.6	1002	25.3	1047	28.4	1092	31.7		
30500	2211	789	13	838	15.6	885	18.3	932	21.3	977	24.1	1020	27	1060	29.9	1103	33.1		
32000	2320	815	14.3	861	17	906	19.7	951	22.7	995	25.8	1037	28.8	1078	31.8				
33500	2429	841	15.6	884	18.4	928	21.2	971	24.2	1014	27.4	1056	30.6	1095	33.7				
35000	2538	867	17.1	908	19.9	951	22.8	991	25.8	1033	29.1	1074	32.5						
36500	2646	894	18.6	933	21.5	974	24.5	1014	27.6	1052	30.9	1093	34.4						
38000	2755	920	20.2	959	23.2	997	26.3	1037	29.6	1074	32.8								
39500	2864	947	22	985	25.1	1021	28.2	1060	31.6	1096	34.9								
41000	2973	974	23.8	1012	27	1047	30.3	1083	33.7										
42500	3081	1001	25.7	1038	29.1	1073	32.5	1106	35.9										

Performance shown is for model LSF with outlet duct. Power ratings (Bhp) do not include transmission losses.

Typical Specifications



Roof mounted, filtered supply fans shall be of the belt-driven, double-width, double-inlet, centrifugal blower type. Hoods shall be louvered penthouses constructed of heavy-gauge extruded aluminum louvers with mitered corners. Hoods shall include insulated and hinged aluminum covers. Base panels shall have prepunched mounting holes. Permanent washable 2-inch aluminum filters shall be provided unless birdscreen is specified.

Fan wheels shall be of the flat blade, backward-inclined type (sizes 12-16) or airfoil type (sizes 18-36), constructed of heavy-gauge steel, and statically and dynamically balanced to ensure smooth, vibration-free operation.

Motors shall be carefully matched to the fan load and furnished at the specified voltage, phase and enclosure.

The fan shaft shall be precision turned, ground and polished steel sized so that the first critical speed shall be at least 25% over the maximum operating speed.

Bearings shall be of the highest quality ball or roller type mounted in cast iron pillow blocks with grease fittings. Bearings shall be selected for a minimum L₁₀ life in excess of 80,000 hours at maximum cataloged operating speeds. Pulleys shall be of the fully machined cast iron type, keyed and securely attached to the wheel and motor shafts. Motor sheaves for motors up to 7½ hp shall be adjustable for final system balancing. Drives shall be sized for a minimum of 150% of driven horsepower. The entire fan and motor assembly shall be mounted on vibration isolators to reduce noise transmission. Lifting lugs shall be provided.

Fans shall be Model LSF as manufactured by Greenheck Fan Corporation of Schofield, Wisconsin, USA.

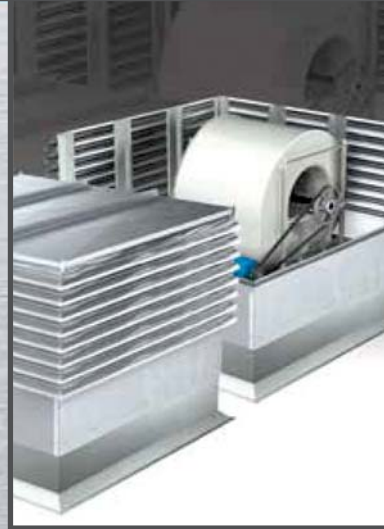

Building Value in Air

Greenheck delivers value to mechanical engineers by helping them solve virtually any air quality challenges their clients face with a comprehensive selection of

top quality, innovative air-related equipment. We offer extra value to contractors by providing easy-to-install, competitively priced, reliable products that arrive on time.

And building owners and occupants value the energy efficiency, low maintenance and quiet dependable operation they experience long after the construction project ends.

Our Commitment

As a result of our commitment to continuous improvement, Greenheck reserves the right to change specifications without notice.

Specific Greenheck product warranties are located on greenheck.com within the product area tabs and in the Library under Warranties.



Prepared to Support Green Building Efforts

